

SILVER CREST®



www.lidl-service.com



BREAD MAKER SBB 850 C1

(GB) (CY)

BREAD MAKER

Operating instructions

(RO)

MAȘINĂ DE FĂCUT PÂINE

Instrucțiuni de utilizare

(DE) (AT) (CH)

BROTBACKAUTOMAT

Bedienungsanleitung

(HR)

PEKAČ KRUHA

Upute za upotrebu

(GR) (CY)

ΑΡΤΟΠΑΡΑΣΚΕΥΑΣΤΗΣ

Οδηγίες χρήσης

IAN 270356

(HR) (RO) (GR)

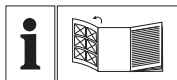

GB CY

Before reading, unfold the page containing the illustrations and familiarise yourself with all functions of the device.

HR

Prje nego što pročitate tekst, otvorite stranicu sa slikama i upoznajte se na osnovu toga sa svim funkcijama uređaja.

RO

Înainte de a citi instrucțiunile, priviți imaginile și familiarizați-vă cu toate funcțiile aparatului.

GR CY

Πριν ξεκινήσετε την ανάγνωση, ανοίξτε τη σελίδα με τις εικόνες και εξοικειωθείτε με όλες τις λειτουργίες της συσκευής.

DE AT CH

Klappen Sie vor dem Lesen die Seite mit den Abbildungen aus und machen Sie sich anschließend mit allen Funktionen des Gerätes vertraut.

GB/CY	Operating instructions	Page	1
HR	Upute za upotrebu	Stranica	21
RO	Instrucțiuni de utilizare	Pagina	43
GR/CY	Οδηγίες χρήσης	Σελίδα	65
DE/AT/CH	Bedienungsanleitung	Seite	89

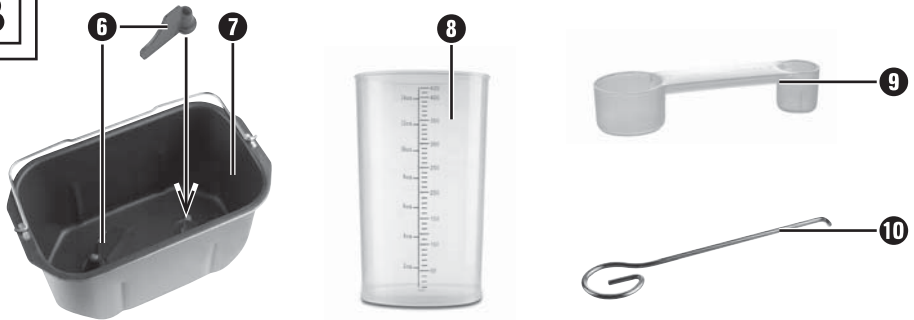
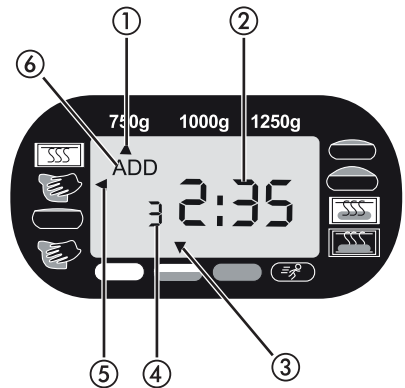
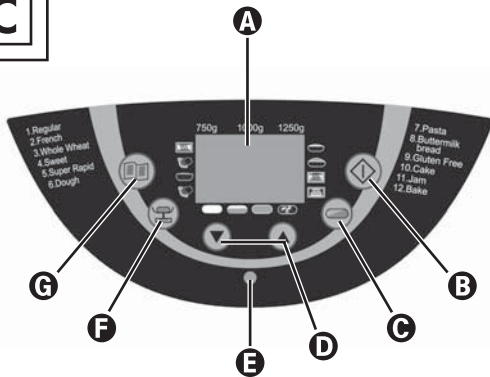
A**B****C**

Contents

Introduction	2
Intended use	2
Package contents	2
Description of the appliance	2
Technical data	2
Safety instructions	3
Before initial use	7
Features	7
Control panel	7
Programme	9
Timer function	10
Before baking	10
Baking bread	11
Cleaning and care	13
Disposal	14
Warranty and service	14
Importer	15
Programme sequence	16
Troubleshooting the bread maker	20

BREAD MAKER

Introduction

Congratulations on the purchase of your new appliance.

You have selected a high-quality product.

The operating instructions are part of this product. They contain important information on safety, usage and disposal. Before using the product, familiarise yourself with all handling and safety guidelines.

Use the product only as described and for the range of applications specified. Please also pass these operating instructions on to any future owner(s).

Intended use

This bread maker is intended only for home use for baking bread or for cooking jams and preserves.

Do not use the appliance for drying foodstuffs or other objects. Do not use the bread maker outdoors.

Use only the accessories recommended by the manufacturer. Other accessories can cause damage to the appliance.

This appliance is intended solely for use in private households.

Not for commercial use!

Package contents

Bread maker

Baking mould

2 kneading blades

Measuring cup

Measuring spoon

Kneading blade remover

Operating instructions

Brief information

Recipe Book

NOTE

- ▶ When unpacking the appliance, check it thoroughly for possible transport damage. If required, contact the Service Centre (see section "Warranty and Service").

Description of the appliance

Figure A:

- 1 Viewing window
- 2 Appliance lid
- 3 Ventilation slots
- 4 Mains cable
- 5 Control panel

Figure B:

- 6 2 kneading blades
- 7 Baking mould for loaves with weights of up to 1250 g
- 8 Measuring cup
- 9 Measuring spoon
- 10 Kneading blade remover

Technical data

Rated voltage: 220 - 240 V ~ /50 Hz

Power consumption: 850 Watt

Safety instructions

- ▶ Please read the operating instructions completely before using the appliance for the first time!

⚠ DANGER – ELECTRIC SHOCK!

- ▶ Always check the power cable and plug before use. To reduce potential risks in the event of damage to the power cable, arrange for it to be examined and repaired as soon as possible by the manufacturer, by Customer Services or by a similarly qualified person.
- ▶ Do not place the power cable over sharp edges or close to hot surfaces or objects. These may damage the insulation of the power cable.
- ▶ When not in use, and before cleaning the appliance, remove the power cable from the plug.
- ▶ Never immerse the bread maker in water or other liquids. Risk of electrical shock!
- ▶ Do not clean the appliance with abrasive cleaning sponges. If parts come loose from the sponge and come into contact with electrical components, there is a risk of electric shock.

⚠ WARNING! RISK OF INJURY!

- ▶ Risk of suffocation! Children can suffocate through the improper use of packaging materials. Dispose of them immediately after unpacking or store them in a place that is out of reach of children.
- ▶ To prevent the risk of tripping accidents, the appliance is equipped with a short power cable.
- ▶ Before taking out or inserting accessories, unplug the appliance and allow it to cool down.
- ▶ Place an extension cable in such a way as to prevent anyone from tripping over it or inadvertently pulling on it.
- ▶ If there are any children nearby, please watch over the appliance closely! If the appliance is not in use, and also before cleaning it, remove the plug from the power socket. Allow the appliance to cool down before removing individual parts.

⚠ WARNING! RISK OF INJURY!

- ▶ This appliance may be used by children of the age of 8 years or more and by persons with reduced physical, sensory or mental capabilities or lack of experience and/or knowledge if they are being supervised or have been instructed with regard to the safe use of the appliance and have understood the potential risks.
- ▶ Do not allow children to play with the appliance.
- ▶ Cleaning and user maintenance may not be carried out by children, unless they are older than 8 years of age and supervised.
- ▶ Children younger than eight years of age must be kept away from the appliance and the power cable.
- ▶ This appliance complies with all pertinent safety regulations. Inspection, repair and technical maintenance may only be performed by a qualified specialist. Improper usage invalidates all claims under the warranty.
- ▶ Attention! The bread maker gets very hot during operation. Do not touch the appliance until it has cooled down, or use oven gloves.
- ▶ Do not move the bread maker if the baking mould contains hot or liquid contents, e.g. jams. There is a risk of burns!
- ▶ Do not attempt to touch the rotating kneading blades during use. There is a risk of injury!
- ▶ During operation, the temperature of exposed surfaces can be very high. Risk of burns!



Caution! Hot surface!

Parts of the appliance get very hot during use!

Risk of burns!

⚠ WARNING! RISK OF FIRE!

- ▶ Do not use an external timing switch or a separate remote control system to operate the appliance.
- ▶ Do not place the appliance near inflammable materials or explosive/combustible gases. Maintain a minimum distance of 10 cm to all other objects.

⚠ WARNING! RISK OF FIRE!

- ▶ Never cover the appliance with a towel or other material. Heat and steam must be able to escape. A fire can be caused if the appliance is covered with inflammable material or comes into contact with inflammable materials, e.g. curtains.
- ▶ Do not place any objects on the appliance and do not cover it during use.
- ▶ Never place aluminium foil or other metallic objects in the bread maker. This could cause a short circuit.
- ▶ Never use more than 700 g of flour when baking and never add more than 1 ¼ packets of dried yeast. The dough could overflow and cause a fire! The only exception to this rule is gluten-free bread. In this case, a maximum of 2 packets of dried yeast may be used (see recipe booklet).

CAUTION – PROPERTY DAMAGE!

- ▶ Ensure that the ventilation slots of the appliance are not obstructed at any time. Risk of overheating!
- ▶ Never leave the appliance unsupervised whilst in use!
- ▶ Only use the appliance inside of buildings.
- ▶ Never place the appliance on or close to a gas or electric cooker, a hot oven or any other heat source. Risk of overheating!
- ▶ The use of accessories not recommended by the manufacturer may cause damage to the appliance. Only use the appliance for its intended purposes. Improper usage invalidates all claims under the warranty.
- ▶ Do not start a baking programme if the baking mould is not in the appliance. This could cause irreparable damage to the appliance.
- ▶ Do not pull on the cable to remove the plug from the socket; always pull on the plug itself.
- ▶ Do not use the bread maker to store foods or utensils.

CAUTION – PROPERTY DAMAGE!

- ▶ Never use the appliance without a baking mould or with an empty one. This will irreparably damage the appliance.
- ▶ Always close the lid during use.
- ▶ Never attempt to remove the baking mould during use.
- ▶ Always place the appliance on a dry, flat and heat-resistant surface.
- ▶ Before plugging the appliance in, check to ensure that the kind of current and mains voltage match the information given on the type plate.
- ▶ If you use an extension cable, ensure that the maximum permitted power rating for the cable corresponds to that of the bread maker.

Before initial use

Unpacking

- Unpack the appliance and remove all packaging materials as well as any stickers and protective films.
- When unpacking the appliance, check it thoroughly for possible transport damage. If required, contact the Service Centre (see section "Warranty and Service").

Initial cleaning

Wipe the baking mould **7**, kneading blades **6** and upper surfaces of the bread maker with a clean moist cloth before taking it into operation. Do not use abrasive sponges or abrasive cleaning agents. Remove the protective foil from the control panel **5** if you have not already done so.

Initial heating

- 1) When **heating for the first time**, place the empty baking mould **7** into the appliance and then close the lid **2**.

⚠ WARNING! RISK OF FIRE!

- ▶ Do not heat the bread maker for more than 5 minutes with an empty baking mould **7**. There is a risk of overheating.

- 2) Select programme 12, as described in the section "Programmes", and press the Start/Stop button **B** to heat up the appliance for 5 minutes.
- 3) After 5 minutes, end the programme by pressing and holding the Start/Stop button **B** until you hear a long signal tone.

NOTE

As the heating elements are lightly greased, you may notice a slight smell when using the appliance for the first time. This is harmless and stops after a short time. Ensure sufficient ventilation; for example, by opening a window.

- 4) Let the appliance cool down completely and once again wipe the baking mould **7**, kneading blades **6** and the outer surfaces of the bread maker with a clean moist cloth.

Features

This bread maker allows you to bake bread just the way you like it.



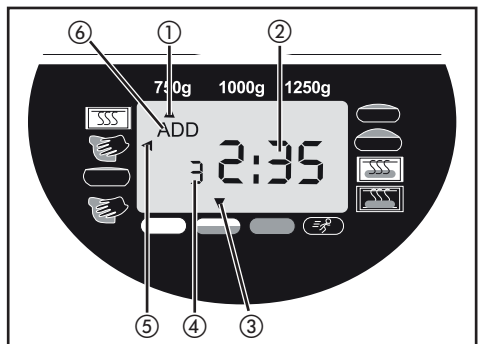
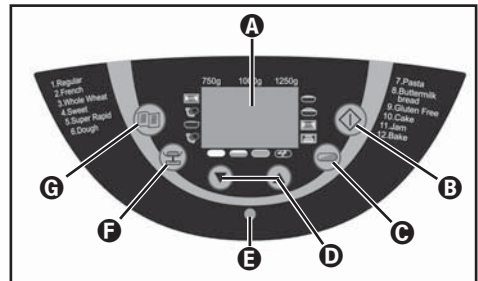

- You can choose from 12 different baking programmes.
- You can use ready-to-use baking mixtures.
- You can prepare dough for rolls and noodles and even make marmalades and jams.
- By using the programme "Gluten-free" you can bake gluten-free baking mixes and recipes containing gluten-free flours, such as cornflour, buckwheat flour or potato flour.

Control panel



A Display

Display for

- ① selecting the weight (750 g, 1000 g, 1250 g)
- ② the remaining baking time in minutes and the preselected programme time
- ③ the selected browning level (Light , Medium , Dark , Rapid )
- ④ the selected programme number
- ⑤ the programme sequence
- ⑥ the addition of ingredients ("ADD")

B Start/Stop

To start and stop operation or to delete a timer programme.

To interrupt operation, briefly press the Start/Stop button **B** until you hear a beep and the time flashes on display **A**. If you press the Start/Stop button **B** again within the next 10 minutes, operation will be resumed. If you forget to restart the programme, it will resume automatically after 10 minutes.

To completely terminate the operation or to delete a programme, press the Start/Stop button **B** for 3 seconds, until you hear a long beep.

NOTE

- ▶ Do not press the Start/Stop button **B** if you want to simply check the condition of the bread. You can check the baking progress through the viewing window **1**.

CAUTION!

- ▶ You should always hear a beep when pressing any button while the appliance is running.

C Browning level (or rapid mode)

Select the browning level or switch into the rapid mode (Light/Medium/Dark/Rapid). Press the browning level button **C** repeatedly, until the arrow appears above the desired browning level. For programmes 1–4 you can, through repeated pressing of the browning level button **C**, activate the rapid mode to shorten the baking process. Press the browning level button **C** repeatedly until the arrow appears above "Rapid" icon. A browning level cannot be selected with the programmes 6, 7 and 11.

D Timer

Time-delayed baking.

NOTE

E Operating light

The operating light **E** lights up when a programme is running.

If you want to start a programme with a time delay, the operating light **E** flashes as soon as the timer setting is confirmed. As soon as the programme starts, the operating light **E** lights up permanently.

F Bread weight

Select the bread weight (750 g/1000 g/1250 g). Press the button repeatedly until the arrow appears under the desired weight. The weight specifications (750 g/1000 g/1250 g) refer to the total amount of ingredients placed in the baking mould **7**.

NOTE

- ▶ The default setting when switching the appliance on is 1250 g. You cannot adjust the bread weight with the Programmes 6, 7, 11 and 12.

ⓐ Programme selection (menu)

Call up the desired baking programme (1 - 12). The programme number appears on the display **Ⓐ** along with the respective baking time.

Memory function

When the appliance is switched back on after a power failure of up to about 10 minutes, the programme will continue from the same point. This, however, does not apply to deleting/ending the baking process or pressing the Start/Stop button **ⓑ** until you hear a long beep.

Viewing window **ⓑ**

You can monitor the baking process through the viewing window **ⓑ**.

Programme

Select the desired programme using the programme selection button **ⓐ**. The corresponding programme number is shown on the display **Ⓐ**.

The baking times are dependent on the selected programme combinations. See section "Programme sequence".

Programme 1: Regular

For white and mixed-flour breads, comprising predominantly wheat and rye. The bread has a compact consistency. Set the degree of browning of the bread using the browning level button **ⓐ**.

Programme 2: French

For light breads from well-milled flour. As a rule, the bread is light and has a crispy crust.

Programme 3: Whole Wheat

For breads made from robust flours, e.g. whole wheat flour and whole rye flour. The bread will be more compact and heavy.

Programme 4: Sweet

For breads with ingredients like fruit juices, coconut flakes, raisins, dried fruit, chocolate or additional sugar. By means of an extended rising phase the bread is lighter and airier.

Programme 5: Super Rapid

Less time is required for kneading, rising and baking. For this programme, however, use only recipes that do not contain any heavy ingredients or heavy varieties of flour. Note that in this programme the bread is less aerated and might not come out quite as tasty.

Programme 6: Dough (kneading)

For the preparation of yeast dough for rolls, pizza or plaits. This programme does not include a baking process.

Programme 7: Pasta

For the preparation of pasta dough. This programme does not include a baking process.

Programme 8: Buttermilk Bread

For breads made with buttermilk or yoghurt.

Programme 9: Gluten Free

For breads made with gluten-free flours and baking mixes. Gluten-free flours take longer to absorb liquids and they have differing rising properties.

Programme 10: Cake

In this programme, the ingredients are kneaded, allowed to rise and then baked. Use baking powder for this programme.

Programme 11: Jam

For making jams, preserves, jellies and fruit spreads.

Programme 12: Bake

For the additional baking of breads that are not brown enough, not baked through or for ready-made doughs. There are no kneading and rising processes in this programme. The bread is kept warm for up to one hour after the baking process. This prevents the bread from becoming too moist. Programme 12 bakes the bread for 60 minutes.

To stop these functions early, press the Start/Stop button **ⓑ** until you hear a long signal tone. To switch the appliance off, remove the plug from the wall power socket.

NOTE

- ▶ In programmes 1, 2, 3, 4, 5, 6, 8 and 9, a signal tone sounds during the sequence and "ADD" ④ appears on the display. Directly after this, add the other ingredients, such as fruit or nuts. You do not need to interrupt the programme.
The kneading blades ⑥ will not chop the ingredients. If you have set the timer, you can put all the ingredients into the baking mould ⑦ at the programme start. In this case, however, fruits and nuts should be chopped beforehand.

Timer function

The timer function allows you to delay the baking process by a preset time.

Use the arrow buttons ▼ and ▲ ① to set the desired completion time for the baking process. The maximum time delay is 15 hours.

⚠ WARNING! RISK OF FIRE!

- ▶ Before you bake a particular type of bread with time delay, try out the recipe first to ensure that the proportions of the ingredients are correct, that the dough is not too firm or too thin, and that the quantities are not too much and could possibly overflow.
- 1) Select a programme. The display ① indicates the required baking time.
 - 2) Using the arrow key ▲ ①, you can delay the end of the programme. The first activation pushes the completion time back to the next full interval of 10 minutes. Each subsequent press of the arrow key ▲ ① delays the completion time by 10 minutes. You can accelerate this procedure by holding the button pressed down. The display shows you the whole period of the baking time and delay time.
If you exceed of the maximum time delay, you can correct the time with the arrow key ▼ ①.
 - 3) Confirm the programming of the timer with the Start/Stop button ②.
The operating light ③ starts to flash. The colon on the display ① flashes and the programmed time starts to run.

As soon as the programme starts, the operating light ③ is on permanently. When the baking process has been completed, you will hear ten beeps and the display ① indicates 0:00.

Example:

It is 8:00 a.m. and you would like to have fresh bread in 7 hours and 30 minutes, in other words at 3:30 p.m. Start by selecting programme 1 and then press the arrow keys ① until 7:30 appears in the display ①, as the time until completion is 7 hours and 30 minutes.

NOTE

- ▶ The timer function cannot be activated with the programme "Jam".

NOTE

- ▶ Please do not use perishable ingredients such as milk, eggs, cream or cheese, etc. when using the time delay function.

Before baking

For a successful baking process, please consider the following factors:

Ingredients

⚠ WARNING! RISK OF FIRE!

- ▶ Remove the baking mould ⑦ from the appliance before filling it with ingredients. If any ingredients drop into the baking chamber, a fire may be caused by them from heating of the heating elements.
- Always add the ingredients into the baking mould ⑦ in the specified sequence.
- To ensure an optimal rising result from the yeast, all ingredients should be at room temperature.

⚠ WARNING! RISK OF FIRE!

- ▶ Never use quantities greater than those specified. If there is too much dough, some could spill over the baking mould **7**, drop onto the hot heating elements and cause a fire.

- Ensure that you measure the ingredients precisely. Even small deviations from the quantities specified in the recipe may affect the baking results.

Baking bread**Preparation****NOTE**

- ▶ Place the bread maker on a level and firm surface.

- 1) Pull the baking mould **7** upwards and out of the appliance.
- 2) Push the kneading blades **6** onto the drive shafts in the baking mould **7**. Ensure that they are firmly seated.
- 3) Add the ingredients into the baking mould **7**. First add the liquids, sugar and salt, then the flour. Add the yeast as the last ingredient.

NOTE

- ▶ Ensure that the yeast does not come into contact with salt or liquids.

- 4) Insert the baking mould **7** again. Ensure that it clicks into place correctly.
- 5) Close the appliance lid **2**.
- 6) Put the power plug into the mains power socket. You will hear a beep and the programme number and the duration for programme 1 will appear on the display **A**.
- 7) Select the programme you want using the programme select button **G**. Every input is acknowledged with a beep.
- 8) If necessary, use button **F** to select the size of bread you want to bake.

- 9) Select the required level of browning **C** for your bread. The arrow on the display **A** shows you if you have selected, light, medium or dark. Here you can also select the setting "Super Rapid" to shorten the time during which the dough rises.

NOTE

- ▶ A browning level cannot be selected for programmes 6, 7 and 11. The function "Rapid" is only available for programmes 1-4. A bread weight cannot be selected for programmes 6, 7, 11 and 12.

- 10) You now have the option of setting the end time of your programme using the timer function. You can enter in a maximum time delay of up to 15 hours.

NOTE

- ▶ This function is not available for programme 11.

Starting a programme

Start the programme with the Start/Stop button **B**.

NOTE

- ▶ Programmes 1, 2, 3, 4, 6 and 8 start with a 10 to 30 minute preheating phase (except Super Rapid, see table for programme sequences). The kneading blades **6** do not move. This is not a malfunction of the appliance.

The programme will carry out the various operations automatically.

You can monitor the programme sequence through the viewing window **1** of your bread maker.

Occasionally, condensation may build up on the viewing window **1** during baking. The appliance lid **2** may be opened during the kneading phase.

NOTE

- ▶ Do not open the appliance lid **2** during the rising or baking phases. The bread could collapse.

Ending a programme

When the baking process has been completed, you will hear ten beeps and the display **A** indicates 0:00. At the end of the programme, the appliance automatically changes to a keep-warm mode for up to 60 minutes.

NOTE

- ▶ This does not apply to programmes 6, 7 and 11.

In this mode, warm air circulates inside the appliance. The keep-warm function can be ended early by keeping the Start/Stop button **B** pressed until a beep is heard.

⚠ DANGER! ELECTRIC SHOCK!

- ▶ Before opening the appliance lid **2**, disconnect the power plug from the socket. The appliance should always be disconnected from the power grid when not in use!

Taking out the bread

Always use pot holders or oven gloves when removing the hot baking mould **7**. Hold the baking mould **7** tilted over a grill tray and shake it lightly until the bread slides out of the baking mould **7**.

If the bread does not slip off the kneading blades **6**, carefully remove the kneading blades **6** using the supplied kneading blade remover **10**.

NOTE

Do not use any metal objects that could cause scratches on the non-stick coating. Rinse the baking mould **7** with warm water directly after removing the bread. This will help prevent the kneading blades **6** becoming stuck on the drive shafts.

TIP

If you remove the kneading hooks **6** from the dough after the last kneading process, the bread will not be torn open when removing it from the baking mould **7**.

- Press the Start/Stop button **B** briefly to pause the programme at the very start of the baking phase or, pull the power plug out of the socket. Ensure that you replace the power plug within 10 minutes so that the baking process can be continued.
- Open the appliance lid **2** and remove the baking mould **7**. With floured hands, you can remove the dough and then pull out the kneading hooks **6**.
- Replace the dough in the back baking mould **7**. Replace the baking mould **7** and close the appliance lid **2**.
- Put the power plug into the socket if necessary. The baking program continues from where it was stopped.

Allow the bread to cool for 15–30 minutes before eating it.

Before cutting the bread, always check to ensure that the kneading blades **6** have been removed from it.

Error messages

- If the display **A** shows "HHH" after the programme has been started, it indicates that the temperature in the bread maker is still too high. Stop the programme and remove the power plug. Open the appliance lid **2** and allow the machine to cool down for 20 minutes before reusing it.
- If a new programme cannot be started directly after the bread maker has completed a baking process, it means the appliance is still too hot. In this case, the display panel reverts to the default setting (programme 1). Open the appliance lid **2** and allow the machine to cool down for 20 minutes before reusing it.

NOTE

- ▶ Do not attempt to reuse the appliance until it has cooled itself down. This functions only in programme 12.

- If "EE0", "EE1" or "LLL" appears on the display after the programme has started, switch the bread maker off and then on again by removing the plug from the socket and then putting it back in. If the failure display persists, contact Customer Service.

Cleaning and care

⚠ DANGER! ELECTRIC SHOCK!

- ▶ Before cleaning the appliance, always remove the plug from the socket and allow the appliance to cool down completely. Protect the appliance from moisture, as this can lead to electric shock. Please also observe the safety instructions.

CAUTION! MATERIAL DAMAGE!

- ▶ The appliance and its accessories are not dishwasher-proof!
- ▶ Do not use any chemical cleaning agents or solvents to clean the bread maker.

Housing, lid, baking chamber

- Remove all residues from the inside of the baking chamber using a wet cloth or a slightly damp soft sponge.
- Wipe both the housing and the lid also only with a moist cloth or sponge. For easier cleaning, the appliance lid ② can be removed from the housing:
 - Open the appliance lid ② until the wedge-shaped plastic hooks fit through the openings of the hinge guides.
 - Pull the appliance lid ② out of the hinge guides.
 - To reassemble the appliance lid ②, plug the plastic hooks through the opening of the hinge guides.

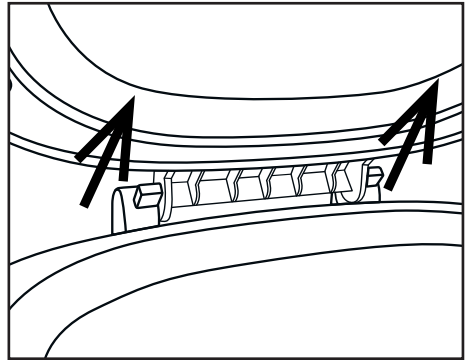

- Dry everything thoroughly and make sure that all parts are dry before reuse.

Baking mould, kneading blades and accessories

CAUTION! MATERIAL DAMAGE!

- ▶ Never immerse the baking mould ⑦ in water or other liquids.
- ▶ The surfaces of the baking mould ⑦ and the kneading blades ⑥ are coated with a non-stick coating. When cleaning the appliance, do not use aggressive detergents, abrasive cleaning agents or objects that may cause scratches to the surfaces.

NOTE

- ▶ Due to moisture and vapours, the surfaces of various parts may change in their appearance over the course of time. This has no influence on the function nor does it reduce the quality of the baking results.
- Before cleaning, remove the baking mould ⑦ and the kneading blades ⑥ from the baking chamber.

- Remove the kneading blades **6** from the baking mould **7**. If the kneading blades **6** cannot be removed from the baking mould **7**, fill the baking mould **7** with hot water for around 30 minutes. The kneading blades **6** should now be easy to remove.

Clean the kneading blades **6** in warm water with mild dishwashing detergent. For stubborn incrustations, you can leave the kneading blades **6** in the washing water until the incrustations can be removed by means of a dishwashing brush. If the mounting holes in the kneading hooks **6** are blocked, these can be carefully cleaned with a wooden toothpick or similar.
Dry the kneading blades **6** thoroughly after cleaning.

- Wipe the exterior surfaces of the baking mould **7** with a moist cloth.
- Clean the interior of the baking mould **7** with warm water and a little dishwashing detergent. If there are incrustations in the baking mould **7**, fill the baking mould **7** with water and add mild dishwashing detergent. Let it soak until the incrustations have softened and can be removed with a dishwashing brush. Afterwards, rinse the baking mould **7** with clean water and dry it off thoroughly.
- Clean the measuring cup **8**, the measuring spoon **9** and the kneading blade remover **10** in warm water with a little mild washing-up liquid. Then rinse all parts with plenty of clean water to remove all detergent residues. Dry everything thoroughly.

Disposal



Never dispose of the appliance in the normal domestic waste. This product is subject to the provisions of European Directive 2012/19/EU.

Dispose of the appliance through an approved disposal centre or at your community waste facility.

Please observe applicable regulations. Please contact your waste disposal facility if you are in any doubt.



Dispose of all packaging materials in an environmentally friendly manner.

Warranty and service

This appliance is provided with a 3-year warranty valid from the date of purchase. This appliance has been manufactured with care and inspected meticulously prior to delivery.

Please retain your receipt as proof of purchase. In the event of a warranty claim, please contact your Customer Service unit by telephone. This is the only way to guarantee free return of your goods.

The warranty only covers claims for material and manufacturing defects, not for transport damage, wearing parts, such as baking trays or dough hooks, or for damage to fragile components such as switches or batteries. This appliance is intended solely for private use and not for commercial purposes.

The warranty shall be deemed void in cases of misuse or improper handling, use of force and modifications/repairs which have not been carried out by one of our authorised Service centres. Your statutory rights are not restricted by this warranty.

The warranty period is not prolonged by repairs effected under the warranty. This also applies to replaced and repaired components. Any damage and defects present at the time of purchase must be reported immediately after unpacking, but no later than two days after the date of purchase. Repairs carried out after expiry of the warranty period shall be subject to charge.

GB Service Great Britain

Tel.: 0871 5000 720 (£ 0.10/Min.)

E-Mail: kompernass@lidl.co.uk

IAN 270356

CY Service Cyprus

Tel.: 8009 4409

E-Mail: kompernass@lidl.com.cy

IAN 270356

Hotline availability:

Monday to Friday 08:00 - 20:00 (CET)

Importer

KOMPERNASS HANDELS GMBH









BURGSTRASSE 21

44867 BOCHUM









GERMANY

www.kompernass.com









Programme sequence

Pro-gramme	1. Regular						2. French					
	Light Medium Dark			Rapid			Light Medium Dark			Rapid		
Size	750 g	1000 g	1250 g	750 g	1000 g	1250 g	750 g	1000 g	1250 g	750 g	1000 g	1250 g
Browning level												
Time (hours)	02:58	03:05	03:15	02:14	02:20	02:25	03:13	03:18	03:25	02:18	02:25	02:30
Preheating (min) 	15	15	20	N/A	N/A	N/A	10	10	15	N/A	N/A	N/A
Kneading 1 (min) 	12	13	13	12	13	13	12	12	15	12	13	13
Rising 1 (min) 	25	25	25	10	10	10	20	20	20	10	10	10
Kneading 2 (min) 	2 3A* 5	2 5A 5	2 5A 5	2 1A 5	2 2A 5	2 2A 5	2 3A* 8	2 5A 8	2 5A 8	2 1A 5	2 2A 5	2 2A 5
Rising 2 (min) 	30	30	30	18	18	18	43	41	35	18	18	18
Rising 3 (min) 	30	30	30	30	30	30	35	35	35	30	30	30
Baking (min) 	56	60	65	56	60	65	60	65	70	60	65	70
Keep warm time (min) 	60	60	60	60	60	60	60	60	60	60	60	60
Add the ingredients (remaining hours)	02:01	02:05	02:10	01:49	01:53	01:58	02:26	02:29	02:28	01:53	01:58	02:03
Presetting the time	15 hrs	15 hrs	15 hrs	15 hrs	15 hrs	15 hrs	15 hrs	15 hrs	15 hrs	15 hrs	15 hrs	15 hrs









*3A means that after 3 minutes of kneading, you will hear 10 beeps and "ADD"  will be displayed at the same time. This reminds you that you can now add ingredients such as fruit or nuts.

Programme	3. Whole Wheat						4. Sweet					
	Light Medium Dark			Rapid			Light Medium Dark			Rapid		
Size	750 g	1000 g	1250 g	750 g	1000 g	1250 g	750 g	1000 g	1250 g	750 g	1000 g	1250 g
Time (hours)	03:18	03:25	03:35	02:24	02:30	02:35	02:56	03:01	03:10	02:10	02:16	02:20
Preheating (min) 	15	15	20	N/A	N/A	N/A	10	10	15	N/A	N/A	N/A
Kneading 1 (min) 	11	12	12	11	13	13	12	12	12	11	12	12
Rising 1 (min) 	30	30	30	10	10	10	25	25	25	10	10	10
Kneading 2 (min) 	2 3A 8	2 5A 8	2 5A 8	2 2A 5	2 2A 5	2 2A 5	2 4A* 6	2 5A 6	2 5A 6	2 1A 6	2 2A 6	2 2A 6
Rising 2 (min) 	38	38	38	23	23	23	35	35	35	18	18	18
Rising 3 (min) 	35	35	35	35	35	35	30	30	30	30	30	30
Baking (min) 	56	60	65	56	60	65	52	56	60	52	56	60
Keep warm time (Min) 	60	60	60	60	60	60	60	60	60	60	60	60
Add the ingredients (remaining hours)	02:17	02:21	02:26	01:59	02:03	02:08	02:03	02:07	02:11	01:46	01:50	01:54
Presetting the time	15 hrs	15 hrs	15 hrs	15 hrs	15 hrs	15 hrs	15 hrs	15 hrs	15 hrs	15 hrs	15 hrs	15 hrs

*4A means that after 4 minutes of kneading, you will hear 10 beeps and "ADD"  will be displayed at the same time. This reminds you that you can now add ingredients such as fruit or nuts.

Programme	5. Super Rapid			6. Dough	7. Pasta	8. Buttermilk Bread			9. Gluten Free		
Browning level	Light Medium Dark			N/A	N/A	Light Medium Dark			Light Medium Dark		
Size	750 g	1000 g	1250 g	N/A	N/A	750 g	1000 g	1250 g	750 g	1000 g	1250 g
Time (hours)	01:15	01:18	01:20	01:50	00:15	03:17	03:21	03:30	02:14	02:20	02:25
Preheating (min) 	N/A	N/A	N/A	10	N/A	25	25	30	N/A	N/A	N/A
Kneading 1 (min) 	8	8	8	12	15	10	10	10	12	13	13
Rising 1 (min) 	N/A	N/A	N/A	10	N/A	20	20	20	10	10	10
Kneading 2 (min) 	N/A 2A 5	N/A 2A 5	N/A 2A 5	N/A 3A 5	N/A N/A N/A	2 5A* 8	2 5A* 8	2 5A* 8	2 1A 5	2 2A 5	2 2A 5
Rising 2 (min) 	N/A	N/A	N/A	25	N/A	45	45	45	18	18	18
Rising 3 (min) 	20	20	20	45	N/A	30	30	30	30	30	30
Baking (min) 	40	43	45	N/A	N/A	52	56	60	56	60	65
Keep warm time (min) 	60	60	60	N/A	N/A	60	60	60	60	60	60
Add the ingredients (remaining hours)	01:05	01:08	01:10	01:15	N/A	02:15	02:19	02:23	01:49	01:53	01:58
Presetting the time	15 hrs	15 hrs	15 hrs	15 hrs	15 hrs	15 hrs	15 hrs	15 hrs	15 hrs	15 hrs	15 hrs

*5A means that after 5 minutes of kneading, you will hear 10 beeps and "ADD"  will be displayed at the same time. This reminds you that you can now add ingredients such as fruit or nuts.

Programme	10. Cake			11. Jam	12. Bake
Browning level	Light Medium Dark			N/A	Light Medium Dark
Size	750 g	1000 g	1250 g	N/A	N/A
Time (hours)	01:30	01:35	01:40	01:20	01:00
Preheating (min) 	N/A	N/A	N/A	N/A	N/A
Kneading 1 (min) 	15	15	15	N/A	N/A
Rising 1 (min) 	N/A	N/A	N/A	15 Heat + kneading	N/A
Kneading 2 (min) 	N/A N/A N/A	N/A N/A N/A	N/A N/A N/A	N/A N/A N/A	N/A N/A N/A
Rising 2 (min) 	N/A	N/A	N/A	N/A	N/A
Rising 3 (min) 	N/A	N/A	N/A	45 Heat + kneading	N/A
Baking (min) 	60	65	70	20 Rise	60
	15 rising	15 rising	15 rising		
Keep warm time (min) 	60	60	60	N/A	60
Add the ingredients (remaining hours)	N/A	N/A	N/A	N/A	N/A
Presetting the time	15 hrs	15 hrs	15 hrs	N/A	15 hrs

Troubleshooting the bread maker

What do I do if the kneading blades 6 are stuck in the baking mould 7 after baking?	Fill the baking mould 7 with hot water and twist the kneading blades 6 to loosen the incrustation underneath.
What happens if the finished bread is left inside the bread maker?	The "Keep warm function" ensures that the bread is kept warm for about 1 hour and also that it is protected against moisture. If the bread remains in the bread maker for longer than 1 hour, it may become moist.
Can the baking mould 7 and kneading blades 6 be cleaned in the dishwasher?	No. Please rinse the baking mould 7 and the kneading blades 6 by hand.
Why doesn't the dough get stirred, even though the motor is running?	Check to see if the kneading blades 6 and the baking mould 7 are correctly engaged.
What do I do if a kneading blade 6 is stuck in the bread?	Remove the kneading blade 6 with the kneading blade remover 10 .
What happens if there is a power failure when a programme is running?	In the case of a power failure of up to 10 minutes, the bread maker will complete the last set programme through to the end.
How long does it take to bake bread?	Please check the times given in the table "Programme sequence".
What weights of breads can I bake?	You can bake breads with weights of 750 g - 1000 g - 1250 g.
Why can I not use the timer function for baking with fresh milk?	Fresh products such as milk or eggs spoil if they remain in the appliance for too long.
Why does the bread maker not start up after the Start/Stop button B has been pressed?	Some baking processes, such as "Warming up" or "Resting" are difficult to recognise. Using the table "Programme sequence" to check which programme section is currently in operation. Verify that the appliance is functioning by checking whether the operation lamp E is on. Check to see if you have pressed the Start/Stop button B correctly. Check to see if the power plug is connected to the power grid.
The appliance crushes the added raisins.	To avoid the crushing of ingredients such as fruit or nuts, add them to the dough after the signal tone has sounded.

Sadržaj

Uvod	22
Namjenska uporaba	22
Opseg isporuke	22
Opis uređaja	22
Tehnički podaci	22
Sigurnosne napomene	23
Prije prve uporabe	27
Osobine	27
Upravljačka ploča	27
Programi	29
Funkcija tajmera	30
Prije pečenja	30
Pečenje kruha	31
Čišćenje i održavanje	33
Zbrinjavanje	34
Jamstvo i servis	34
Uvoznik	35
Proizvođač:	35
Tijek programa	36
Otklanjanje smetnji automata za pečenje kruha	40

PEKAČ KRUHA

Uvod

Čestitamo na kupnji Vašeg novog uređaja.

Time ste se odlučili za visokovrijedan proizvod.

Upute za rukovanje predstavljaju sastavni dio ovog proizvoda. One sadrže važne napomene za sigurnost, rukovanje i zbrinjavanje. Prije uporabe uređaja upoznajte se sa svim pripadajućim uputama za uporabu i svim sigurnosnim napomenama. Proizvod koristite isključivo na opisani način i u navedenim područjima uporabe. U slučaju predaje proizvoda trećim osobama priložite i predajte i svu dokumentaciju.

Namjenska uporaba

Automat za pečenje kruha koristite isključivo za pečenje kruha i pripremu marmelade/džemova u domaćinstvu.

Uređaj ne koristite za sušenje namirnica ili uporabnih predmeta. Automat za pečenje kruha ne koristite na otvorenom.

Koristite isključivo opremu koju preporučuje proizvođač. Uporaba opreme koju nije preporučio proizvođač može uzrokovati oštećenja uređaja. Ovaj je uređaj namijenjen isključivo za uporabu u privatnim domaćinstvima.

Uređaj ne koristite u komercijalne svrhe!

Opseg isporuke

Pekač kruha

Kalup za pečenje

2 Kuke za miješanje

Mjerna čaša

Mjerna žlica

Uređaj za skidanje kuke za miješanje

Upute za uporabu

Kratka informacija

Knjižica s receptima

NAPOMENA

- ▶ Nakon raspakiranja prekontrolirajte cjelovitost uređaja i provjerite postoje li transportna oštećenja. Ako je potrebno, kontaktirajte servis (vidi poglavlje "Jamstvo i servis").

Opis uređaja

Slika A:

- 1 Prozorčić
- 2 Poklopac uređaja
- 3 Otvori za ventilaciju
- 4 Mrežni kabel
- 5 Upravljačka ploča

Slika B:

- 6 2 Kuke za miješanje
- 7 Kalup za pečenje za težinu kruha do 1250 g
- 8 Mjerna čaša
- 9 Mjerna žlica
- 10 Uređaj za odstranjivanje kuke za miješanje

Tehnički podaci

Nazivni napon: 220 - 240 V ~ / 50 Hz

Snaga: 850 W

Izjava o sukladnosti za ovaj proizvod dostupna je na internet stranici www.lidl.hr

Sigurnosne napomene

- ▶ Molimo da prije uporabe uređaja u cijelosti pročitate upute uporabu!

⚠ OPASNOST - STRUJNI UDAR!

- ▶ Prije svake uporabe provjerite mrežni kabel i mrežni utikač. Ako dođe do oštećenja mrežnog priključnog kabela, isti mora zamijeniti proizvođač, servis za kupce ili slična kvalificirana osoba, kako bi se izbjegle opasne situacije.
- ▶ Mrežni kabel ne postavljajte preko oštrih ivica ili u blizini vrućih površina ili predmeta. Može doći do oštećenja izolacije kabela.
- ▶ Kada uređaj ne koristite i prije čišćenja uređaja izvucite mrežni utikač iz utičnice.
- ▶ Automat za pečenje kruha ne uranjajte u vodu ili druge tekućine. Postoji opasnost od strujnog udara!
- ▶ Uređaj ne čistite spužvama za čišćenje koje grebu. Ako se čestice takve spužve oslobode i dođu u dodir s električnim dijelovima, postoji opasnost od strujnog udara.

⚠ UPOZORENJE! OPASNOST OD OZLJEDA!

- ▶ Opasnost od gušenja! Djeca se mogu ugušiti uslijed nenamjenske uporabe ambalaže. Ambalažu zbrinite odmah nakon raspakiranja uređaja, ili je čuvajte na mjestu nedostupnom djeci.
- ▶ Kako bi se izbjeglo spoticanje ili nezgode, uređaj je opremljen kratkim mrežnim kabelom.
- ▶ Prije vađenja ili umetanja dijelova pribora, uređaj ostavite da se ohladi i izvucite mrežni utikač.
- ▶ Produžni kabel postavite tako da se nitko preko njega ne može spotaknuti i da ga se ne može nehотиčno povući.
- ▶ Ako su djeca u blizini, molimo dobro nadgledajte uređaj! Kada se uređaj ne koristi, ili prije čišćenja uređaja, obavezno izvucite utikač iz utičnice. Prije skidanja pojedinih dijelova uređaj ostavite da se ohladi.

⚠ UPOZORENJE! OPASNOST OD OZLJEDA!

- ▶ Djeca od navršениh 8 godina kao i osobe sa smanjenim fizičkim, senzornim ili mentalnim sposobnostima ili nedostatkom iskustva i/ili znanja uređaj smiju koristiti ako su pod nadzorom, ili ako su primile i razumjele upute o uporabi uređaja, kao i opasnosti koje proizlaze iz uporabe uređaja.
- ▶ Djeca se ne smiju igrati uređajem.
- ▶ Čišćenje i održavanje od strane korisnika ne smiju obavljati djeca ukoliko nisu navršila 8 godina starosti i ako nisu pod nadzorom.
- ▶ Djecu mlađu od 8 godina treba držati dalje od uređaja i priključnog kabela.
- ▶ Ovaj uređaj zadovoljava važeće sigurnosne odredbe. Kontrolu, popravak i tehničko servisiranje smije obavljati isključivo kvalificirano stručno osoblje. U protivnomse gubi pravo na jamstvo.
- ▶ Oprez! Automat za pečenje kruha se jako zagrijava. Uređaj dirajte tek kada se ohladi ili za to koristite kuhinjsku krpu.
- ▶ Automat za pečenje kruha ne pomjerajte ako se u kalupu za pečenje nalazi vruć ili tekući sadržaj, primjerice džem. Postoji opasnost od opekline!
- ▶ Za vrijeme korištenja uređaja nikada ne dodirujte rotirajuće kuke za miješanje. Postoji opasnost od ozljeda!
- ▶ Za vrijeme rada temperatura površine koju je moguće dohvatiti može biti vrlo visoka. Opasnost od opekline!



Pozor! Vruća površina!

Dijelovi uređaja za vrijeme rada postaju vrlo vrući!

Opasnost od opekline!

⚠ UPOZORENJE! OPASNOST OD POŽARA!

- ▶ Ne koristite vanjski uklopni sat ili posebne sustave za daljinsko upravljanje uređajem.
- ▶ Uređaj ne postavljajte u blizini zapaljivih materijala, eksplozivnih i/ili zapaljivih plinova. Uređaj od drugih predmeta mora biti odmaknut najmanje 10 centimetara.
- ▶ Uređaj nikada ne prekrivajte krpama ili drugim materijalima. Vrućina i para moraju moći ishlapati. Do požara može doći ukoliko se uređaj prekrije ili dođe u kontakt sa zapaljivim materijalom, kao što su npr. zavjese.
- ▶ Ne postavljajte nikakve predmete na uređaj i ne prekrivajte ga.
- ▶ Nikada ne umećite aluminijsku foliju ili druge metalne predmete u automat za pečenje kruha. To može dovesti do kratkoga spoja.
- ▶ Prilikom pečenja nikada ne prekoračujte količinu od 700 g brašna i nikada ne umećite više od 1 ¼ paketića suhog kvasca. Može doći do prelijevanja tijesta i uslijed toga do požara!
To se ne odnosi na kruh koji ne sadrži gluten. Kod takve vrste kruha možete dodati maksimalno 2 paketića suhog kvasca (vidi knjižicu s receptima).

OPREZ – OŠTEĆENJE UREĐAJA!

- ▶ Pazite da otvori za ventilaciju uređaja nisu prekriveni. Opasnost od pregrijavanja!
- ▶ Uređaj za vrijeme rada nikada ne ostavljajte bez nadzora!
- ▶ Uređaj koristite isključivo u zatvorenim prostorima.
- ▶ Uređaj nikada ne postavljajte na plinske ili električne štednjake niti pokraj njih, na vruće pećnice ili druge izvore topline. Opasnost od pregrijavanja!
- ▶ Uporaba pribora koji nije preporučio proizvođač može uzrokovati oštećenja. Uređaj koristite isključivo za predviđenu namjenu. U protivnom se gubi pravo na jamstvo.

OPREZ – OŠTEĆENJE UREĐAJA!

- ▶ Program za pečenje pokrenite samo s umetnutim kalupom za pečenje. U protivnom može doći do nepopravljivih oštećenja uređaja.
- ▶ Utikač nikada ne izvlačite iz utičnice povlačeći za mrežni kabel.
- ▶ Automat za pečenje kruha ne koristite za čuvanje namirnica ili opreme.
- ▶ Uređaj nikada ne koristite s praznim kalupom za pečenje ili bez njega. To uzrokuje nepopravljiva oštećenja uređaja.
- ▶ Za vrijeme rada uvijek zatvorite poklopac.
- ▶ Nikada ne uklanjajte kalup za pečenje dok uređaj radi.
- ▶ Uređaj postavite isključivo na suhu i ravnu površinu otpornu na visoke temperature.
- ▶ Prije priključivanja provjerite odgovaraju li vrsta struje i mrežni napon podacima na tipskoj ploči.
- ▶ Ako koristite produžni kabel, maksimalna dopuštena struja za kabel mora odgovarati snazi automata za pečenje kruha.

Prije prve uporabe

Raspakiranje

- Raspakirajte uređaj i odstranite svu ambalažu kao i eventualno prisutne naljepnice i zaštitne folije.
- Nakon raspakiranja prekontrolirajte cjelovitost uređaja i provjerite postoje li transportna oštećenja. Ako je potrebno, kontaktirajte servis (vidi poglavlje "Jamstvo i servis").

Prvo čišćenje

Kalup za pečenje **7**, kuku za miješanje **6** i vanjske površine automata za pečenje kruha prije puštanja u rad prebrišite čistom i suhom krpom. Ne koristite grube spužve za čišćenje ili abrazivna sredstva za čišćenje. Ako još niste, odstranite zaštitnu foliju na polju za upravljačkoj ploči **5**.

Prvo zagrijavanje

- 1) Samo prilikom **prvog zagrijavanja** u uređaj umetnite prazan kalup za pečenje **7** i zatvorite poklopac uređaja **2**.



UPOZORENJE! OPASNOST OD POŽARA!

- ▶ Automat za pečenje kruha ne smije se s praznim kalupom za pečenje **7** zagrijavati duže od 5 minuta. Postoji opasnost od pregrijavanja.
- 2) Izaberite program 12, kao što je opisano u poglavlju „Programi“ i pritisnite tipku Start/Stop **B**, da biste uređaj zagrijavali 5 minuta.
 - 3) Kako biste završili program, nakon 5 minuta pritisnite tipku Start/Stop **B**, sve dok se ne oglasi dugi zvučni signal.

NAPOMENA

Pošto su grijači lagano namašćeni, prilikom prvog puštanja uređaja u rad može doći do nastanka blagog neugodnog mirisa. Ovo je bezopasno, i miris nakon kratkog vremena nestaje. Osigurajte dostatno prozračivanje, primjerice otvorite prozor.

- 4) Ostavite uređaj da se potpuno ohladi, pa kalup za pečenje **7**, kuke za miješanje **6** i vanjsku površinu automata za pečenje kruha još jednom prebrišite čistom vlažnom krpom.

Osobine

Pomoću automata za pečenje kruha možete peći kruh prema vlastitom ukusu.



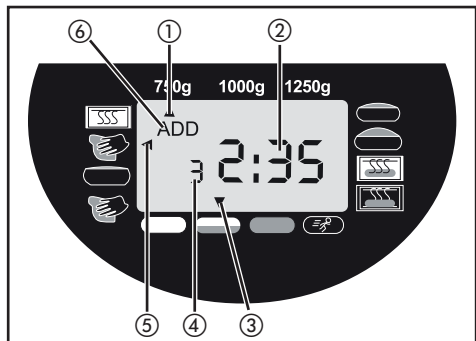
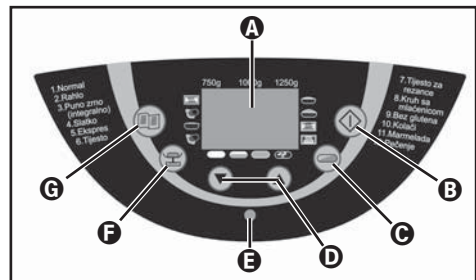

- Možete birati između 12 različitih programa.
- Možete koristiti gotove mješavine za pečenje.
- Možete mijesiti tjesteninu i tijesta za žemlje ili praviti marmelade.
- Pomoću programa „Bez glutena“ možete peći bezglutenske mješavine za pečenje i koristiti recepte s bezglutenskim vrstama brašna, kao što su kukuruzno brašno, heljдино i krumpirovo brašno.

Upravljačka ploča



A Zaslon

Prikaz za

- ① odabir težine (750 g, 1000 g, 1250 g)
- ② preostalo vrijeme rada u satima i programirano vrijeme odgode početka
- ③ odabrani stupanj tamnjenja (svijetlo , srednje , tamno , brzo )
- ④ odabrani broj programa
- ⑤ tijek programa
- ⑥ dodavanje sastojaka („ADD“)

B Start / Stop

Za pokretanje i završavanje rada ili za brisanje programiranja tajmera.

Ako želite zaustaviti rad, kratko pritisnite Start/Stop-tipku **B**, dok se ne oglasi zvučni signal i vrijeme na zaslonu **A** počne treperiti. Ponovnim pritiskanjem tipke Start/Stop **B** u roku od 10 minuta moguće je nastaviti rad. Ukoliko zaboravite nastaviti program, isti se nakon deset minuta nastavlja automatski.

Ako želite potpuno prekinuti rad ili izbrisati postavke, tipku Start/Stop **B** držite pritisnutu 3 sekunde dok se ne oglasi dugi zvučni signal.

NAPOMENA

- ▶ Ne pritiščite tipku Start/Stop **B** ako samo želite provjeriti stanje kruha. Postupak pečenja možete provjeriti kroz prozorčić **1**.

POZOR!

- ▶ Pritiskanjem bilo koje tipke dok uređaj radi, mora se oglašiti zvučni signal.

C Stupanj tamnjenja (ili brzi način rada)

Odabir stupnja tamnjenja ili prebacivanje u brzi način rada (svijetlo/srednje/tamno/brzo). Pritišćite tipku za određivanje stupnja tamnjenja **C** više puta, sve dok se strelica ne pojavi iznad željenog stupnja. Za programe 1 - 4 možete uzastopnim pritiskanjem tipke za stupanj tamnjenja **C** aktivirati brzi način rada kako biste skratili postupak pečenja. Pritišćite tipku za stupanj tamnjenja **C** sve dok se strelica ne pojavi iznad oznake "Brzo". Kod programa 6, 7 i 11 ne može se birati stupanj tamnjenja.

D Tajmer

Vremenski odgođeno pečenje.

NAPOMENA

E Lampica indikatora pogona

Lampica indikatora pogona **E** svijetli dok traje izvođenje programa.

Ako neki od programa želite pokrenuti pomoću funkcije tajmera s odgodom vremena početka, lampica indikatora pogona **E** počinje treptati čim potvrdite postavku tajmera. Čim se program pokrene, lampica indikatora pogona **E** trajno svijetli.

F Težina kruha

Odabir težine kruha (750 g/ 1000 g/ 1250 g).

Ovu tipku pritiščite više puta, sve dok se strelica ne pojavi ispod željene težine. Oznake težine (750 g/ 1000 g/ 1250 g) odnose se na količinu sastojaka napunjenih u kalup za pečenje **7**.

NAPOMENA

- ▶ Unaprijed podešena postavka prilikom uključivanja uređaja je 1250 g. Kod programa 6, 7, 11 i 12 ne možete podesiti težinu kruha.

G Izbor programa (izbornik)

Pozivanje željenog programa za pečenje (1-12). Na zaslonu **A** se pojavljuje broj programa i odgovarajuće vrijeme pečenja.

Funkcija memorije

U slučaju nestanka električne energije u trajanju do otprilike 10 minuta, prekinuti program se nastavlja na istom mjestu. To međutim ne vrijedi kod brisanja/završavanja postupka pečenja ili prilikom pritiskanja tipke Start/Stop **B** sve dok se ne oglasi zvučni signal.

Prozorčić 1

Kroz prozorčić **1** možete promatrati postupak pečenja.

Programi

Pomoću tipke za Izbor programa **G** možete birati željeni program. Odgovarajući broj programa prikazat će se na zaslonu **A**. Vremena pečenja ovisna su o odabranim kombinacijama programa. Vidi poglavlje „Tijek programa“.

Program 1: Normal

Za bijeli i miješani kruh, koji se uglavnom sastoji od pšeničnog ili raženog brašna. Kruh ima kompaktnu konzistenciju. Tamnjenje kruha podesite pomoću tipke Stupanj tamnjenja **C**.

Program 2: Rahlo

Za lagani kruh od fino mljevenog brašna. Kruh je uglavnom rahle konzistencije i hrskave kore.

Program 3: Puno zrno

Za vrste kruha od snažnijih sorti brašna, na primjer brašna od punog zrna ili raženog brašna. Kruh je kompaktniji i teži.

Program 4: Slatko

Za vrste kruha sa sastojcima od voćnog soka, pahuljica kokosovog oraha, groždica, suhog voća, čokolade ili dodatnog šećera. Uslijed duže faze dizanja tijesta kruh postaje lakši i rahliji.

Program 5: Ekspres

Za miješanje, dizanje tijesta i pečenje potrebno je manje vremena. Za ovaj program su međutim podobni samo oni recepti, koji ne sadrže teške sastojke ili snažnije vrste brašna. Imajte na umu da kruh pripremljen pomoću ovog programa može biti manje rahli i manje ukusan.

Program 6: Tijesto (miješenje)

Za izradu tijesta s kvascem, za zemlje, pizzu ili pletenice. Kod ovog programa se ne izvodi postupak pečenja.

Program 7: Tijesto za rezance

Za izradu tijesta za rezance. Kod ovog programa se ne izvodi postupak pečenja.

Program 8: Kruh sa mlaćenicom

Za vrste kruha, koji se pripremaju s mlaćenicom ili jogurtom.

Program 9: Bez glutena

Za vrste kruha od bezglutenskog brašna i bezglutenske mješavine za pečenje. Vrstama brašna bez glutena potrebno je duže vrijeme za upijanje tekućine, i ova brašna imaju drugačije osobine u pogledu dizanja tijesta.

Program 10: Kolači

Sastojci se kod ovog programa mijese, tijesto se diže i zatim peče. Za ovaj program koristite prašak za pecivo.

Program 11: Marmelada

Za pripremanje marmelade, džemova, želea i voćnih namaza.

Program 12: Pečenje

Za dodatno pečenje kruhova koji su ispalili previše svijetli ili nisu dovoljno pečeni, te za gotova tijesta. Svi postupci miješenja ili mirovanja tijesta kod ovog su programa isključeni. Toplina kruha održavat će se do jednog sata nakon završetka postupka pečenja. Na taj način se sprečava da kruh bude previše vlažan. Program 12 kruh peče 60 minuta.

Da biste ove funkcije prekinuli prije isteka predviđenog vremena, pritisnite tipku Start/Stop **B** sve dok se ne oglasi dugi zvučni signal. Za isključivanje uređaja izvucite utikač iz utičnice.

NAPOMENA

- ▶ Kod programa 1, 2, 3, 4, 5, 6, 8 i 9 se za tijekom programa oglašava zvučni signal, te se pojavljuje oznaka „ADD“ (6) na zaslonu. Neposredno nakon toga dodajte ostale sastojke poput plodova voća ili lješnjaka. Za to nije potrebno prekidati program. Sastojci se neće usitniti kukom za miješanje (6). Kada ste podesili tajmer, sve sastojke možete dodati u kalup za pečenje (7) u trenutku početka programa. Plodove voća i lješnjake u tom slučaju prije dodavanja treba malo usitniti.

Funkcija tajmera

Funkcija tajmera omogućava vremenski odgođeno pečenje.

Tipkama sa strelicama ▼ i ▲ (D) možete podesiti željeno vrijeme završetka postupka pečenja. Maksimalna odgoda vremena iznosi 15 sati.

⚠ UPOZORENJE! OPASNOST OD POŽARA!

- ▶ Prije pečenja kruha pomoću funkcije tajmera, najprije isprobajte odgovarajući recept kako biste osigurali da je međusobni odnos sastojaka ispravan, da tijesto nije previše tvrdo ili rijetko, i da količina nije prevelika, zbog čega bi tijesto moglo isteći iz kalupa.

- 1) Izaberite program. Zaslom (A) prikazuje vrijeme potrebno za pečenje.
- 2) Pomoćutipke sa strelicom ▲ (D) možete pomaknuti kraj programa. Prilikom prvog aktiviranja kraj programa se pomiče do sljedeće desetice. Svakim daljnjim pritiskom tipke sa strelicom ▲ (D) vrijeme kraja pomičete za 10 minuta. Pritiskanjem tipke sa strelicom ubrzat ćete ovaj postupak. Zaslom prikazuje ukupno vremensko trajanje pečenja i vremenske odgode. U slučaju prekoračenja moguće vremenske odgode, vrijeme možete korigirati pomoću tipke sa strelicom ▼ (D).
- 3) Potvrdite postavku tajmera tipkom Start/Stop (B).

Lampica indikator pogona (E) počinje treperiti. Dvotočka na zaslonu (A) treperi, a programirano vrijeme počinje teći.

Čim program krene, lampica indikatora pogona (E) počinje trajno svijetliti. Prilikom završavanja postupka pečenja, zvučni signal će se oglasiti deset puta, a zaslon (A) prikazuje 0:00.

Primjer:

Sada je 8.00 sati, a Vi za 7 sati i 30 minuta, dakle u 15:30 sati, želite imati svjež kruh. Prvo odaberite program 1, a zatim pritisćite tipke sa strelicama (D) toliko dugo, dok se na zaslonu (A) ne pojavi prikaz 7:30, jer vrijeme do kraja pečenja iznosi 7 sati i 30 minuta.

NAPOMENA

- ▶ Kod programa „Marmelada“ funkcija tajmera nije dostupna.

NAPOMENA

- ▶ Ne koristite funkciju tajmera kada obrađujete pokvarljive namirnice poput jaja, mlijeka, tučenog vrhnja ili sira.

Prije pečenja

Za uspješan postupak pečenja u obzir uzmete sljedeće čimbenike:

Sastojci

⚠ UPOZORENJE! OPASNOST OD POŽARA!

- ▶ Izvadite kalup za pečenje (7) iz kućišta, prije nego umetnete sastojke. Ako sastojci dospiju u prostor za pečenje, zagrijavanje grijača može dovesti do požara.
- Sastojke uvijek umetnite u kalup za pečenje (7) navedenim redoslijedom.
- Svi sastojci moraju biti zagrijani na sobnu temperaturu kako bi se omogućilo optimalno dizanje kvasca.

⚠ UPOZORENJE! OPASNOST OD POŽARA!

- ▶ Ni u kom slučaju ne koristite količine veće od navedenih. Prevelika količina tijesta može isticati iz kalupa za pečenje **7** i na vrućim grijaačima izazvati požar.
- Pripazite na točno mjerenje količina sastojaka. Samo mala odstupanja od količina navedene u receptu mogu utjecati na rezultat pečenja.

Pečenje kruha

Priprema

NAPOMENA

- ▶ Automat za pečenje kruha postavite na ravnu i čvrstu podlogu.

- 1) Izvadite kalup za pečenje **7** iz uređaja.
- 2) Utaknite kuke za miješanje **6** na pogonsku osovinu u kalupu za pečenje **7**. Obratite pozornost na to da čvrsto ulegnu.
- 3) Umetnite sastojke Vašeg recepta u kalup za pečenje **7**. Najprije dodajte tekućine, šećer i sol, a zatim brašno, te kvasac kao zadnji sastojak.

NAPOMENA

- ▶ Obratite pažnju na to da kvasac ne dođe u dodir sa solju ili tekućinama.

- 4) Zatim kalup za pečenje **7** ponovo umetnite u uređaj. Obratite pažnju na to da ispravno ulegne.
- 5) Zatvorite poklopac uređaja **2**.
- 6) Utaknite mrežni utikač u utičnicu. Oglasiti će se signalni ton i na zaslonu **A** se pojavljuje broj programa i vrijeme trajanja za program 1.
- 7) Izaberite željeni program pomoću tipke za odabir programa **G**. Svaki unos potvrđuje se zvučnim signalom.
- 8) Po potrebi odaberite veličinu kruha pomoću tipke **F**.

- 9) Odaberite stupanj tamnjenja **G** Vašeg kruha. Na zaslonu **A** strelica pokazuje jeste li podesili svijetlu, srednju ili tamnu postavku stupnja tamnjenja. Ovdje možete odabrati i postavku „Brzo“ kako biste skratili vrijeme dizanja tijesta.

NAPOMENA

- ▶ Za programe 6, 7 i 11 funkcija „Stupanj tamnjenja“ nije moguća. Funkcija „Brzo“ dostupna je samo kod programa 1 - 4. Za programe 6, 7, 11 i 12 podešavanje težine kruha nije moguće.

- 10) Sada imate mogućnost preko funkcije tajmera podesiti vrijeme završetka programa. Možete unijeti maksimalnu vremensku odgodu od 15 sati.

NAPOMENA

- ▶ Za program 11 ova funkcija nije moguća.

Pokretanje programa

Sada pokrenite program pomoću tipke Start/Stop **B**.

NAPOMENA

- ▶ Programi 1, 2, 3, 4, 6 i 8 pokreću se s fazom predgrijavanja od 10 do 30 minuta (osim brzog načina rada, vidi tablicu Tijek programa). Kuke za miješanje **6** se pritom ne pokreću. To ne predstavlja grešku u uređaju.

Program automatski izvodi razne radne korake.

Tijek programa možete promatrati kroz prozorčić **1** Vašeg automata za pečenje kruha. Povremeno za vrijeme postupka pečenja može doći do kondenziranja vlage na prozorčiću **1**. Poklopac uređaja **2** možete otvoriti tijekom faze miješanja.

NAPOMENA

- ▶ Poklopac uređaja **2** ne otvarajte za vrijeme dizanja tijesta ili pečenja. Kruh bi mogao pasti.

Završavanje programa

Prilikom završavanja postupka pečenja, deset puta će se oglasiti zvučni signal a zaslon **A** prikazuje 0:00.

Prilikom završetka programa uređaj se automatski prebacuje na pogon za održavanje temperature u trajanju do 60 minuta.

NAPOMENA

- To ne vrijedi za programe 6, 7 i 11.

Pritom topli zrak cirkulira u uređaju. Funkciju za održavanje temperature možete prekinuti prije isteka tako što ćete tipku Start/Stop **B** držati pritisnutu do oglašavanja zvučnog signala.

⚠ OPASNOST! STRUJNI UDAR!

- Izvucite mrežni utikač iz utičnice, prije nego otvorite poklopac uređaja **2**. Ako uređaj ne upotrebljavate, uvijek ga odvojite od strujne mreže!

Vađenje kruha

Prilikom vađenja kalupa za pečenje **7** uvijek koristite kuhinjske krpe ili zaštitne rukavice. Držite kalup za pečenje **7** koso iznad rešetke i lagano protresite, kako bi se kruh odvojio od kalupa za pečenje **7**.

Ako se kruh ne odvoji od kuka za miješanje **6**, pažljivo odstranite kuke za miješanje **6** pomoću uređaja za odstranjivanje kuka za miješanje **10**.

NAPOMENA

Ne koristite metalne predmete koji bi mogli ogrebat i sloj protiv prljanja. Odmah nakon vađenja kruha, kalup za pečenje **7** isperite toplom vodom. Tako ćete spriječiti da se kuke za miješanje **6** zaglave na pogonskoj osovini.

SAVJET

Ako kuke za miješanje **6** izvadite nakon zadnjeg miješenja, kruh neće ispucati prilikom vađenja iz kalupa za pečenje **7**.

- Kratko pritisnite tipku Start/Stop **B** kako biste program prekinuli na samom početku faze pečenja, ili izvucite utikač iz mrežne utičnice. Mrežni utikač u roku od 10 minuta morate ponovo povezati sa strujnom mrežom, kako bi se postupak pečenja mogao nastaviti.

- Otvorite poklopac uređaja **2** i izvadite kalup za pečenje **7**. Nabrašnjenim rukama možete izvaditi tijesto i odvojiti kuke za miješanje **6**.

- Tijesto ponovo umetnite u kalup za pečenje **7**. Kalup za pečenje **7** vratite u uređaj i zatvorite poklopac uređaja **2**.

- Po potrebi uključite mrežni utikač u utičnicu. Program za pečenje se nastavlja.

Kruh prije konzumacije ostavite da se hladi 15 - 30 minuta.

Prije rezanja kruha uvijek provjerite da se u tijestu ne nalazi kuka za miješanje **6**.

Prikazi smetnji

- Ako zaslon **A** pokazuje „HHH“ nakon pokretanja programa, to znači da je temperatura automata za pečenje kruha još previsoka. Zaustavite program i izvucite mrežni utikač. Otvorite poklopac uređaja **2** i ostavite uređaj 20 minuta da se ohladi prije nego ga nastavite koristiti.

- Ako ne možete pokrenuti novi program nakon što je automat za pečenje kruha završio prethodni program, to znači da je uređaj još prevruć. U tom slučaju prikaz na zaslonu prelazi na osnovnu postavku (program 1). Otvorite poklopac uređaja **2** i ostavite uređaj 20 minuta da se ohladi prije nego što ga nastavite koristiti.

NAPOMENA

- Ne pokušavajte pokrenuti uređaj dok se još nije ohladio. To je moguće samo kod programa 12.

- Ako se na zaslonu pojavi oznaka „EEO“, „EE1“ ili „LLL“ nakon pokretanja programa, prvo isključite automat za pečenje kruha i zatim ga opet uključite. To učinite izvlačenjem i ponovnim ukapčanjem mrežnog utikača iz utičnice. Ako se smetnja i dalje prikazuje, obratite se servisu za kupce.

Čišćenje i održavanje

⚠ OPASNOST! STRUJNI UDAR!

- ▶ Prije svakog čišćenja izvucite mrežni utikač iz utičnice i pričekajte da se uređaj potpuno ohladi. Zaštitite uređaj od vlage, jer u protivnom može doći do strujnog udara. Obratite pažnju i na sigurnosne napomene.

POZOR! OŠTEĆENJE PROIZVODA!

- ▶ Dijelovi uređaja odnosno dijelovi opreme nisu prikladni za pranje u perilici posuđa!
- ▶ Za čišćenje automata za pečenje kruha ne koristite kemijska sredstva za čišćenje ili razrjeđivače.

Kućište, poklopac, prostor za pečenje

- Uklonite sve ostatke naslaga u prostoru za pečenje pomoću vlažne krpe ili blago navlažene spužve.
- Kućište i poklopac također prebrišite blago navlaženom krpom ili spužvom. U svrhu lakšeg čišćenja možete poklopac uređaja ② skinuti s kućišta:
 - Otvorite poklopac uređaja ②, sve dok klinasti plastični elementi šarnira ne mogu proći kroz otvore vodilice šarnira.
 - Povlačenjem izvadite poklopac uređaja ② iz vodilica šarnira.
 - Da biste poklopac uređaja ② montirali, provedite plastične elemente šarnira kroz otvore vodilica šarnira.

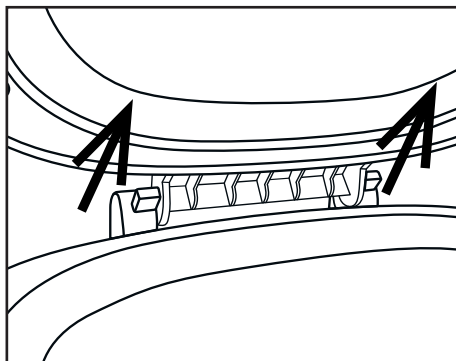

- Sve dobro osušite i osigurajte da prije ponovne uporabe svi dijelovi budu suhi.

Kalup za pečenje, kuke za miješanje i oprema

POZOR! OŠTEĆENJE PROIZVODA!

- ▶ Kalup za pečenje ⑦ nikada ne uranjajte u vodu ili druge tekućine.
- ▶ Površine kalupa za pečenje ⑦ i kuka za miješanje ⑥ opremljene su zaštitnim slojem protiv lijepljenja. Prilikom njihovog čišćenja ne koristite agresivna sredstva, abrazivna sredstva ili predmete koji mogu izazvati ogrebotine na površinama.

NAPOMENA

- ▶ Uslijed vlage i pare izgled površina se tijekom vremena može promijeniti. Ova pojava ne predstavlja smetnju u funkcioniranju uređaja i ne umanjuje njegovu kvalitetu.
- Prije čišćenja kalup za pečenje ⑦ i kuke za miješanje ⑥ izvadite iz prostora za pečenje.

- Kuke za miješanje **6** izvadite iz kalupa za pečenje **7**. Ako kuke za miješanje **6** ne možete odvojiti od kalupa za pečenje **7**, napunite kalup za pečenje **7** vrućom vodom i pustite da odstoji oko 30 minuta. Kuke za miješanje **6** bi se sada trebale moći odvojiti.

Očistite kuke za miješanje **6** u toploj vodi i dodajte blago sredstvo za pranje suđa. Kod tvrdokornih naslaga ostavite kuke za miješanje **6** da se natapaju u vodi za pranje suđa, sve dok naslage ne možete skinuti pomoću četke za pranje posuđa.

Ako je držač umetka u kuki za miješanje **6** začepljen, možete ga pažljivo očistiti pomoću drvenog štapića.

Kuke za miješanje **6** nakon čišćenja temeljito osušite.

- Vanjsku stranu kalupa za pečenje **7** prebrišite vlažnom krpom.
- Očistite unutrašnjost kalupa za pečenje **7** toplom vodom i manjom količinom sredstva za pranje suđa. Ako se stvore naslage u kalupu za pečenje **7**, kalup za pečenje **7** napunite vodom i dodajte blago sredstvo za pranje posuđa. Pustite da odstoji sve dok naslage ne omekšaju, nakon čega ih možete odvojiti četkom za pranje suđa. Kalup za pečenje **7** nakon toga isperite velikom količinom čiste vode i dobro ga osušite.
- Očistite mjernu čašu **8**, mjernu žlicu **9** i uređaj za odstranjivanje kuka za miješanje **10** u toploj vodi i dodajte blago sredstvo za pranje suđa. Nakon toga dijelove uređaja isperite čistom vodom kako biste uklonili ostatke sredstva za pranje posuđa. Sve zajedno dobro osušite.

Zbrinjavanje



Uređaj nikako ne smijete bacati s običnim kućnim otpadom. Ovaj proizvod podliježe europskoj direktivi 2012/19/EU.

Uređaj zbrinite preko autoriziranog poduzeća za zbrinjavanje ili preko Vaše komunalne ustanove za zbrinjavanje otpada.

Poštujte aktualno važeće propise. U slučaju dvojbe obratite se mjesnom poduzeću za zbrinjavanje otpada.



Svu ambalažu zbrinite na ekološki ispravan način.

Jamstvo i servis

Na ovaj uređaj odobravamo jamstvo u trajanju od 3 godine od datuma kupnje. Uređaj je pažljivo proizveden i prije isporuke brižljivo provjeren.

Molimo sačuvajte račun kao dokaz o kupnji. Moli-mo vas da u slučaju jamstvenog zahtjeva nazovete telefonski broj nadležnog servisa. Samo na taj način možemo osigurati besplatno slanje robe.

Jamstvo vrijedi samo za greške materijala ili greške u izradi, ali ne vrijedi za transportna oštećenja, potrošne dijelove kao što su forme za pečenje ili kuke za miješanje, niti za oštećenja lomljivih dijelova, npr. prekidača ili baterija. Proizvod je namijenjen isključivo za privatnu, nekomercijalnu uporabu.

Jamstvo prestaje vrijediti u slučaju zlorporabe, nepravilnog korištenja, primjene sile i zahvata na uređaju koje nije obavila za to ovlaštena podružnica servisa. Ovo jamstvo ne ograničava Vaša zakonska prava.

Korištenje prava na jamstvo ne produžuje jamstveni rok. To vrijedi i za zamijenjene i popravljene dijelove. Štete i nedostatke koji eventualno postoje već prilikom kupovine treba javiti neposredno nakon raspakiranja, a najkasnije u roku od dva dana nakon datuma kupnje. Nakon isteka jamstvenog roka izvršeni popravci se naplaćuju.

HR Servis Hrvatska

Tel.: 0800 777 999

E-Mail: kompernass@lidl.hr

IAN 270356

Dostupnost dežurne telefonske linije:

Ponedjeljak do petak od 8:00 - 20:00 sati (SEV)

HR

Uvoznik

Lidl Hrvatska d.o.o. k.d.,

p.p. 61

10020 Novi Zagreb

Proizvođač:

KOMPERNASS HANDELS GMBH









BURGSTRASSE 21

44867 BOCHUM









GERMANY

www.kompernass.com









Tijek programa

Program	1. Normal						2. Rahlo					
	Svijetlo Srednje Tamno			Brzo			Svijetlo Srednje Tamno			Brzo		
Stupanj tamnjenja												
Veličina	750 g	1000 g	1250 g	750 g	1000 g	1250 g	750 g	1000 g	1250 g	750 g	1000 g	1250 g
Vrijeme (sati)	2:58	3:05	3:15	2:14	2:20	2:25	3:13	3:18	3:25	2:18	2:25	2:30
Predgrijavanje (min) 	15	15	20	N/A	N/A	N/A	10	10	15	N/A	N/A	N/A
Miješanje 1 (min) 	12	13	13	12	13	13	12	12	15	12	13	13
Dizanje 1 (min) 	25	25	25	10	10	10	20	20	20	10	10	10
Gnječenje 2 (min) 	2 3A* 5	2 5A 5	2 5A 5	2 1A 5	2 2A 5	2 2A 5	2 3A* 8	2 5A 8	2 5A 8	2 1A 5	2 2A 5	2 2A 5
Dizanje 2 (min) 	30	30	30	18	18	18	43	41	35	18	18	18
Dizanje 3 (min) 	30	30	30	30	30	30	35	35	35	30	30	30
Pečenje (min) 	56	60	65	56	60	65	60	65	70	60	65	70
Održavanje topline (min) 	60	60	60	60	60	60	60	60	60	60	60	60
Dodavanje sastojaka (sati preostalo)	2:01	2:05	2:10	1:49	1:53	1:58	2:26	2:29	2:28	1:53	1:58	2:03
Podешavanje vremena odgode početka	15h	15h	15h	15h	15h	15h	15h	15h	15h	15h	15h	15h









* 3A znači, da se nakon 3 minute miješanja oglašava 10 zvučnih signala i istovremeno se na zaslonu pojavljuje poruka „ADD“ . To Vas podsjeća na to, da sada možete dodati sastojke kao što su plodovi voća ili lješnjaci.

Program	3. Puno zrno						4. Slatko					
	Svijetlo Srednje Tamno			Brzo			Svijetlo Srednje Tamno			Brzo		
Veličina	750 g	1000 g	1250 g	750 g	1000 g	1250 g	750 g	1000 g	1250 g	750 g	1000 g	1250 g
Vrijeme (sati)	3:18	3:25	3:35	2:24	2:30	2:35	2:56	3:01	3:10	2:10	2:16	2:20
Predgrijavanje (min) 	15	15	20	N/A	N/A	N/A	10	10	15	N/A	N/A	N/A
Miješanje 1 (min) 	11	12	12	11	13	13	12	12	12	11	12	12
Dizanje 1 (min) 	30	30	30	10	10	10	25	25	25	10	10	10
Gnječenje 2 (min) 	2 3A 8	2 5A 8	2 5A 8	2 2A 5	2 2A 5	2 2A 5	2 4A* 6	2 5A 6	2 5A 6	2 1A 6	2 2A 6	2 2A 6
Dizanje 2 (min) 	38	38	38	23	23	23	35	35	35	18	18	18
Dizanje 3 (min) 	35	35	35	35	35	35	30	30	30	30	30	30
Pečenje (min) 	56	60	65	56	60	65	52	56	60	52	56	60
Održavanje topline (min) 	60	60	60	60	60	60	60	60	60	60	60	60
Dodavanje sastojaka (sati preostalo)	2:17	2:21	2:26	1:59	2:03	2:08	2:03	2:07	2:11	1:46	1:50	1:54
Podешavanje vremena odgode početka	15h	15h	15h	15h	15h	15h	15h	15h	15h	15h	15h	15h

* 4A znači, da se nakon 4 minute miješanja oglašava 10 zvučnih signala i istovremeno se na zaslonu pojavljuje poruka „ADD“ . To Vas podsjeća na to, da sada možete dodati sastojke kao što su plodovi voća ili lješnjaci.

Program	5. Ekspres			6. Ti- jesto	7. Tije- sto za rezance	8. Kruh sa mlaćenicom			9. Bez glutena		
Stupanj tamnjenja	Svijetlo Srednje Tamno			N/A	N/A	Svijetlo Srednje Tamno			Svijetlo Srednje Tamno		
Veličina	750 g	1000 g	1250 g	N/A	N/A	750 g	1000 g	1250 g	750 g	1000 g	1250 g
Vrijeme (sati)	1:15	1:18	1:20	1:50	0:15	3:17	3:21	3:30	2:14	2:20	2:25
Predgrijavanje (min) 	N/A	N/A	N/A	10	N/A	25	25	30	N/A	N/A	N/A
Miješanje 1 (min) 	8	8	8	12	15	10	10	10	12	13	13
Dizanje 1 (min) 	N/A	N/A	N/A	10	N/A	20	20	20	10	10	10
Gnječenje 2 (min) 	N/A 2A 5	N/A 2A 5	N/A 2A 5	N/A 3A 5	N/A N/A N/A	2 5A* 8	2 5A* 8	2 5A* 8	2 1A 5	2 2A 5	2 2A 5
Dizanje 2 (min) 	N/A	N/A	N/A	25	N/A	45	45	45	18	18	18
Dizanje 3 (min) 	20	20	20	45	N/A	30	30	30	30	30	30
Pečenje (min) 	40	43	45	N/A	N/A	52	56	60	56	60	65
Održavanje topline (min) 	60	60	60	N/A	N/A	60	60	60	60	60	60
Dodavanje sastojaka (sati preostalo)	1:05	1:08	1:10	1:15	N/A	2:15	2:19	2:23	1:49	1:53	1:58
Podešavanje vremena odgode početka	15h	15h	15h	15h	15h	15h	15h	15h	15h	15h	15h

* 5A znači, da se nakon 5 minute miješanja oglašava 10 zvučnih signala i istovremeno se na zaslonu pojavljuje poruka „ADD“ . To Vas podsjeća na to, da sada možete dodati sastojke kao što su plodovi voća ili lješnjaci.

Program	10. Kolači			11. Marmelada	12. Pečenje
Stupanj rumenila	Svijetlo Srednje Tamno			N/A	Svijetlo Srednje Tamno
Veličina	750 g	1000 g	1250 g	N/A	N/A
Vrijeme (sati)	1:30	1:35	1:40	1:20	1:00
Predgrijavanje (min) 	N/A	N/A	N/A	N/A	N/A
Gnječenje 1 (min) 	15	15	15	N/A	N/A
Dizanje 1 (min) 	N/A	N/A	N/A	15 Toplina + miješenje	N/A
Gnječenje 2 (min) 	N/A N/A N/A	N/A N/A N/A	N/A N/A N/A	N/A N/A N/A	N/A N/A N/A
Dizanje 2 (min) 	N/A	N/A	N/A	N/A	N/A
Dizanje 3 (min) 	N/A	N/A	N/A	45 Toplina + miješenje	N/A
Pečenje (min) 	60	65	70	20 Dizanje	60
	15 Dizanje	15 Dizanje	15 Dizanje		
Održavanje topline (min) 	60	60	60	N/A	60
Dodavanje sastojaka (sati preostalo)	N/A	N/A	N/A	N/A	N/A
Podешavanje vremena odgode početka	15h	15h	15h	N/A	15h

Otklanjanje smetnji automata za pečenje kruha

Što učiniti kada kuka za miješanje 6 nakon pečenja ostane u kalupu za pečenje 7 ?	Ulijte vruću vodu u kalup za pečenje 7 i okrenite kuku za miješanje 6 , da biste otpustili naslage koje su se zapekle.
Što se događa kada gotov kruh ostane u automatu za pečenje?	Pomoću „Funkcije održavanja temperature“ osigurava se da se temperatura kruha održi otprilike sat vremena, i da se kruh zaštiti od vlage. Ukoliko kruh u automatu za pečenje kruha ostane duže od 1 sata, mogao bi navući vlagu.
Jesu li kalup za pečenje 7 i kuke za miješanje 6 prikladni za pranje u perilici posuđa?	Ne. Molimo Vas da kalup za pečenje 7 i kuku za miješanje 6 perete ručno.
Zašto se tijesto ne mijesi, premda motor radi?	Provjerite jesu li kuke za miješanje 6 i kalup za pečenje 7 ispravno ulegli u ležište.
Što učiniti kada kuka za miješanje 6 ostane u kruhu?	Odstranite kuku za miješanje 6 pomoću uređaja za odstranjivanje kuke za miješanje 10 .
Što će se dogoditi u slučaju nestanka električne energije za vrijeme izvođenja programa?	U slučaju nestanka struje u trajanju do 10 minuta, automat za pečenje kruha dovršit će zadnji izvođeni program.
Koliko dugo traje pečenje kruha?	Molimo Vas da za točna vremena pogledate tablicu „Tijek programa“.
Koje težine kruha mogu peći?	Možete peći kruhove težine 750 g - 1000 g - 1250 g.
Zašto ne mogu koristiti funkciju tajmera prilikom pečenja sa svježim mlijekom?	Svježi proizvodi kao što su mlijeko ili jaja se kvare ako predugo ostanu u uređaju.
Što se dogodilo ako automat za pečenje kruha ne radi nakon što ste pritisnuli tipku Start/Stop B ?	Pojedine radne korake poput „podgrijavanja“ ili „mirovanja“ nije lako prepoznati. Pomoću tablice „Tijek programa“ provjerite koji dio programa se upravo izvodi. Provjerite rad uređaja tako što ćete provjeriti svijetli li lampica indikatora pogona B . Provjerite jeste li ispravno pritisnuli tipku Start/Stop B . Provjerite je li mrežni utikač ispravno priključen na strujnu mrežu.
Uređaj usitnjava dodane grožđice.	Da biste izbjegli usitnjavanje sastojaka poput plodova voća i lješnjaka, iste dodajte u tijesto tek nakon što se oglasi zvučni signal.



KARTA ZA NARUDŽBU SBB 850 C1

► www.kompernass.com

NARUČENA KOLIČINA

(maks. 3 kompleta po narudžbi)

OPIS ARTIKLA

JEDINIČNA CIJENA

UKUPAN IZNOS

- ▶ 1 Pekarska forma uklj. 2 kuke za miješanje



77,- HRK



HRK

+

uklj. troškove za
poštarninu, rukovanje,
pakiranje i otpremu.

40,- HRK

- ▶ 4 Kuke za miješanje



77,- HRK



HRK

+

uklj. troškove za
poštarninu, rukovanje,
pakiranje i otpremu.

25,- HRK

- ▶ Napomena: Ako se Vaša narudžba sastoji od više artikala (4-člani komplet kuka za gnječenje i forma za pečenje), uvijek morate platiti višu cijenu za slanje od 40 HRK!

= _____ **HRK**

NAČIN PLAĆANJA

Transfer

(Mjesto, Datum)

(Potpis)

KARTA ZA NARUDŽBU SBB 850 C1

► www.komperrass.com



1) U polje „pošiljatelj/naručilac“ unesite svoje ime, svoju adresu i svoj broj telefona
(za eventualna povratna pitanja) tiskanim slovima.

2) Transferirajte ukupan iznos unaprijed na račun

Microtec sistemi d.o.o.

Account number:

2360000-1101550399

Bank: Zagrebačka banka

■ Prilikom transfera kao svrhu upotrebe navedite artikal, kao i vaše ime i mjesto stanovanja.

■ Zatim popuno ispunjenu kartu za narudžbu u omotnici pošaljite na našu dolje navedenu poštansku adresu.

Ovlašteni servis: Microtec sistemi d.o.o.

Koprivnička 27 a

10000 Zagreb

POŠILJATELU / NARUČILAC
(molimo potpuno i TISKANIM SLOVIMA ispuniti!)

Ime, prezime

Ulica

Broj/Mjesto

Telefon

VAŽNO

- Molimo vas, da dovoljno frankirate pošiljku.
- Napišite svoje ime kao pošiljatelja na omotnicu.

Cuprins

Introducere	44
Utilizarea conform destinației	44
Furnitura	44
Descrierea aparatului	44
Date tehnice	44
Indicații de siguranță	45
Înainte de prima utilizări	49
Caracteristici	49
Panoul de comandă	49
Programe	51
Funcția de temporizare	52
Înainte de coacere	52
Coacerea pâinii	53
Curățarea și îngrijirea	55
Eliminarea	56
Garanția și service-ul	56
Importator	57
Derularea programului	58
Remediarea defecțiunilor de la mașina de făcut pâine	62

MAȘINĂ DE FĂCUT PÂINE

Introducere

Felicitări pentru cumpărarea noului dvs. aparat.

Prin aceasta v-ați decis pentru un produs de calitate superioară. Instrucțiunile de utilizare fac parte integrantă din acest produs. Acestea cuprind informații importante pentru siguranță, utilizare și eliminare. Înainte de utilizarea produsului, familiarizați-vă cu toate indicațiile privind operarea și siguranța.

Utilizați acest produs numai în modul descris și numai în scopurile menționate. În cazul transmiterii aparatului unei alte persoane, predați-i, de asemenea, documentele aferente acestuia.

Utilizarea conform destinației

Folosiți mașina de făcut pâine numai în acest scop și pentru prepararea de dulceață/gemuri de casă.

Nu utilizați aparatul pentru uscarea alimentelor sau a altor obiecte. Nu utilizați mașina de făcut pâine în aer liber.

Nu utilizați decât accesoriile recomandate de producător. Accesoriile care nu au fost recomandate pot deteriora aparatul.

Acest aparat este destinat exclusiv uzului casnic.

Este interzisă utilizarea în scopuri profesionale!

Furnitura

Mașină de făcut pâine

Formă pentru copt

2 palete de frământat

Pahar gradat

Lingură de măsurat

Cârlig de extragere a paletelor de frământat

Instrucțiuni de utilizare

Ghid scurt de utilizare

Carte de rețete

INDICAȚIE

- ▶ După despachetare verificați dacă aparatul este complet și nu prezintă deteriorări în urma transportului. Dacă este cazul, apelați departamentul de service (a se vedea Capitolul „Garanția și service-ul”).

Descrierea aparatului

Figura A:

- ❶ Fereastră de control
- ❷ Capacul aparatului
- ❸ Fantă de aerisire
- ❹ Cablu de alimentare
- ❺ Panou de comandă

Figura B:

- ❻ 2 Palete de frământat
- ❼ Formă de copt pentru pâine cu greutatea până la 1250 g
- ❽ Pahar gradat
- ❾ Lingură de măsurat
- ❿ Cârlig de extragere a paletelor de frământat

Date tehnice

Tensiune nominală: 220 - 240 V ~ / 50 Hz

Consum: 850 wați

Indicații de siguranță

- ▶ Citiți întregul manual de utilizare înainte de a folosi aparatul!

⚠ PERICOL DE ELECTROCUTARE!

- ▶ De fiecare dată înaintea utilizării verificați cablul de alimentare și ștecărul. Pentru a evita orice pericole, la defectarea cablului de alimentare al aparatului, acesta trebuie înlocuit de către producător, de către serviciul clienți al acestuia sau de către o altă persoană calificată.
- ▶ Nu pozați cablul de alimentare peste margini ascuțite sau în apropierea unor suprafețe sau obiecte fierbinți. Izolația cablului se poate distruge.
- ▶ În momentul în care aparatul nu este folosit sau înainte de curățare scoateți ștecărul din priză.
- ▶ Nu introduceți mașina de făcut pâine în apă sau în alte lichide. Pericol de electrocutare!
- ▶ Nu curățați aparatul cu bureți abrazivi. Dacă se desprind particule din burete, care apoi intră în contact cu anumite componente electrice, există pericol de electrocutare.

⚠ AVERTIZARE! PERICOL DE RĂNIRE!

- ▶ Pericol de sufocare! Copiii se pot sufoca din cauza manipulării necorespunzătoare a materialelor de ambalare. Eliminați ambalajele imediat după despachetare sau păstrați-le într-un loc inaccesibil copiilor.
- ▶ Pentru a evita pericolele de împiedicare sau de accidentare, aparatul este dotat cu un cablu de alimentare scurt.
- ▶ Lăsați aparatul să se răcească și extrageți ștecărul din priză înainte de a demonta sau monta anumite componente ale accesoriilor.
- ▶ Pozați cablul prelungitor astfel încât nimeni să nu se împiedice de el sau să poată trage neintenționat de el.
- ▶ Supravegheați cu atenție aparatul atunci când se află copii în apropiere! Dacă nu utilizați aparatul, precum și înainte de curățare, scoateți ștecărul din priză. Înainte de demontarea componentelor, așteptați să se răcească aparatul.

⚠️ AVERTIZARE! PERICOL DE RĂNIRE!

- ▶ Acest aparat poate fi utilizat de copii începând cu vârsta de 8 ani, cât și de persoane cu abilități fizice, senzoriale sau mentale reduse sau fără experiență și/sau fără cunoștințe necesare, dacă sunt supravegheați sau dacă au fost instruiți cu privire la utilizarea sigură a acestui aparat și au înțeles pericolele cu privire la acesta.
- ▶ Copiilor le este interzis să se joace cu aparatul.
- ▶ Curățarea și întreținerea destinate utilizatorului nu se vor efectua de către copii, cu excepția cazului în care aceștia au vârsta peste 8 ani și sunt supravegheați.
- ▶ Copiii cu vârsta sub 8 ani nu vor fi lăsați lângă aparat sau lângă cablul de conexiune.
- ▶ Acest aparat corespunde prevederilor relevante de securitate. Verificările, reparațiile, întreținerea tehnică trebuie realizate numai de către un distribuitor de specialitate. În caz contrar se pierde garanția.
- ▶ **Precauție!** Mașina de făcut pâine se încălzește. Atingeți aparatul abia în momentul în care s-a răcit sau utilizați o lavetă pentru a-l manevra.
- ▶ Nu mutați mașina de făcut pâine atunci când în forma de copt se află conținut fierbinte sau lichid, de exemplu, gem. Pericol de arsuri!
- ▶ În timpul utilizării evitați contactul cu paletele de frământat, aflate în mișcare de rotație. Pericol de rănire!
- ▶ În timpul utilizării temperatura suprafeței accesibile poate fi foarte ridicată. Pericol de arsuri!



Atenție! Suprafață fierbinte!

Anumite componente ale aparatului se încălzesc foarte tare în timpul utilizării!

Pericol de arsuri!

⚠ AVERTIZARE! PERICOL DE INCENDIU!

- ▶ Nu utilizați temporizatoare externe sau sisteme separate de comandă de la distanță pentru operarea aparatului.
- ▶ Nu amplasați aparatul în apropierea unor materiale inflamabile, gaze explozive și/sau inflamabile. Aparatul trebuie să se găsească la o distanță de 10 cm față de alte obiecte.
- ▶ Nu acoperiți niciodată aparatul cu un prosop sau cu alte materiale. Căldura și aburul trebuie să se degaje. Dacă acoperiți aparatul cu materiale inflamabile sau dacă intră în contact cu astfel de materiale, de exemplu draperii, se pot produce incendii.
- ▶ Nu așezați obiecte pe aparat și nu îl acoperiți.
- ▶ Nu introduceți niciodată folie de aluminiu sau alte obiecte metalice în mașina de făcut pâine. Aceasta ar putea provoca un scurtcircuit.
- ▶ Nu depășiți niciodată cantitatea prevăzută de 700 g de făină și nu adăugați niciodată mai mult de 1 ¼ pliculeț de drojdie uscată. Aluatul se poate revărsa și poate cauza un incendiu!
Excepția o reprezintă pâinea fără gluten. La aceasta pot fi adăugate maxim 2 pliculețe de drojdie uscată (a se vedea cartea de rețete).

ATENȚIE – PAGUBE MATERIALE!

- ▶ Aveți grijă ca fantele de aerisire ale aparatului să nu fie acoperite. Pericol de supraîncălzire!
- ▶ Nu lăsați niciodată aparatul nesupravegheat în timpul funcționării!
- ▶ Utilizați aparatul doar în spații interioare.
- ▶ Nu amplasați aparatul niciodată lângă sau pe o mașină de gătit electrică sau pe gaz, un cuptor încins sau alte surse de căldură. Pericol de supraîncălzire!
- ▶ Utilizarea unor accesorii nerecomandate de producător poate duce la deteriorări ale aparatului. A se utiliza numai în scopul prevăzut. În caz contrar se pierde garanția.

ATENȚIE – PAGUBE MATERIALE!

- ▶ Programul de făcut pâine poate fi pornit doar dacă forma de copt a fost introdusă.
În caz contrar, aparatul poate fi deteriorat iremediabil.
- ▶ Trageți de ștecăr și nu de cablul de alimentare pentru a scoate ștecărul din priză.
- ▶ Nu utilizați mașina de făcut pâine pentru a depozita alimente sau ustensile în ea.
- ▶ Nu utilizați aparatul niciodată fără formă de copt sau cu formă de copt goală. Aceasta ar provoca defecțiuni iremediabile aparatului.
- ▶ Închideți întotdeauna capacul în timpul funcționării.
- ▶ Nu îndepărtați forma de copt niciodată în timpul funcționării.
- ▶ Așezați aparatul doar pe o suprafață uscată, plană și rezistentă la căldură.
- ▶ Înainte de conectarea la rețeaua electrică verificați dacă aceasta corespunde cu informațiile de pe plăcuța de identificare.
- ▶ Dacă utilizați un cablu prelungitor, puterea maximă admisă a cablului trebuie să corespundă cu cea a mașinii de făcut pâine.

Înainte de prima utilizări

Despachetarea

- Despachetați aparatul și îndepărtați orice material de ambalare, precum și eventuale etichete sau folii de protecție.
- După despachetare verificați dacă aparatul este complet și nu prezintă deteriorări în urma transportului. Dacă este cazul, apălați departamentul de service (a se vedea Capitolul „Garanția și service-ul”).

Prima curățare

Înainte de punerea în funcțiune ștergeți forma de copt **7**, paletetele de frământat **6** și suprafața exterioară a mașinii de făcut pâine cu o lavetă curată și umedă. Nu utilizați bureți sau substanțe de curățare abrazive. În cazul în care nu ați făcut-o deja, îndepărtați folia de protecție de pe panoul de comandă **5**.

Prima încălzire

- 1) Doar la **prima încălzire** se va introduce forma de copt **7** goală înăuntru mașinii și se închide capacul aparatului **2**.

⚠ AVERTIZARE! PERICOL DE INCENDIU!

- ▶ Nu lăsați mașina de făcut pâine să se încălzească mai mult de 5 minute cu forma de copt **7** goală. Există pericolul de supraîncălzire.
- 2) Selectați programul 12, după cum a fost descris în Capitolul „Programe”, apoi apăsați Pornire/Oprire **B** pentru a încălzi aparatul timp de 5 minute.
 - 3) Pentru a încheia programul, după 5 minute, apăsați tasta Pornire/Oprire **B**, până auziți un semnal sonor lung.

INDICAȚIE

Deoarece elementele de încălzire sunt ușor gresate, la prima punere în funcțiune se poate degaja un ușor miros. Acesta nu este dăunător și va dispărea în scurt timp. Asigurați aerisirea suficientă a încăperii, de exemplu prin deschiderea unei ferestre.

- 4) Lăsați aparatul să se răcească complet și apoi ștergeți din nou forma de copt **7**, paletetele de frământat **6** și suprafața exterioară a mașinii de făcut pâine cu o lavetă curată, umedă.

Caracteristici

Cu ajutorul mașinii de făcut pâine aveți posibilitatea de a face pâine după gustul dvs.



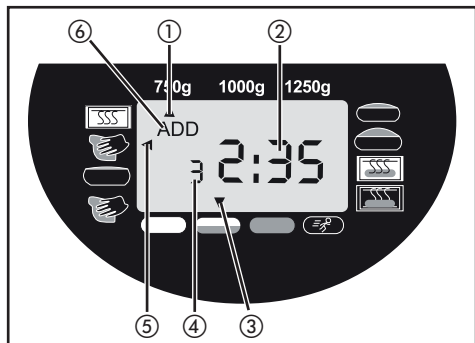
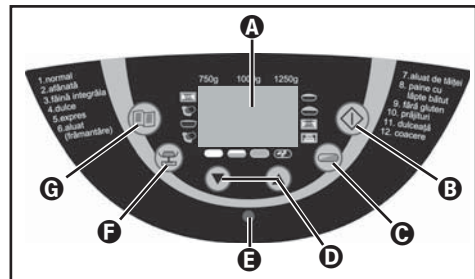

- Puteți alege între 12 programe diferite.
- Puteți procesa amestecuri gata preparate.
- Puteți frământa aluat de paste sau de chifle ori puteți face dulceață.
- Cu ajutorul programului „Fără gluten” puteți face pâine din amestecuri și făinuri fără gluten, cum ar fi făina de porumb, făina de hrișcă sau de cartofi.

Panoul de comandă



A Ecranul

Afișaj pentru

- ① selectarea greutății (750 g, 1000 g, 1250 g)
- ② timpul de funcționare rămas în ore și timpul preselectat și programat
- ③ gradul de rumenire selectat (puțin rumenit , mediu rumenit , bine rumenit , rapid )
- ④ numărul programului selectat
- ⑤ derularea programului
- ⑥ adăugarea ingredientelor („ADD”)

B Pornire/Oprire

Pentru pornirea sau oprirea funcționării sau pentru a șterge o programare a temporizatorului.

Pentru a opri funcționarea, apăsați pentru scurt timp tasta Pornire/Oprire **B**, până când se aude un semnal sonor și clipește timpul pe ecran **A**. Printr-o nouă apăsare a tastei Pornire/Oprire **B** funcționarea aparatului poate fi continuată în interval de 10 minute. Dacă vizați să reluați programul, acesta este continuat în mod automat după 10 minute.

Pentru a încheia complet funcționarea sau pentru a șterge setările, apăsați tasta Pornire/Oprire **B** timp de 3 secunde, până se aude un semnal sonor lung.

INDICAȚIE

- ▶ Nu apăsați tasta Pornire/Oprire **B** dacă doriți doar să verificați starea pâinii. Verificați procesul de coacere prin fereastra de control **1**.

ATENȚIE!

- ▶ La apăsarea tuturor tastelor, se va auzi un semnal sonor, cu excepția situației în care aparatul se află în funcțiune.

C Grad de rumenire (sau mod rapid)

Selectarea gradului de rumenire sau comutarea în modul rapid (puțin rumenit/mediu rumenit/bine rumenit/rapid). Apăsați în mod repetat tasta pentru gradul de rumenire **C**, până ce săgeata apare deasupra gradului de rumenire dorit. Pentru programele 1 - 4, prin apăsarea repetată a tastei pentru gradul de rumenire **C** puteți activa regimul rapid, pentru a reduce timpul de coacere. Apăsați tasta pentru gradul de rumenire **C** până ce săgeata apare deasupra cuvântului „Rapid”. În cazul programelor 6, 7 și 11 nu poate fi selectat niciun grad de rumenire.

D Temporizator

Coacere temporizată.

INDICAȚIE

B Bec indicator al stării de funcționare

Becul indicator al stării de funcționare **B** indică prin aprinderea sa faptul că programul se află în derulare.

Dacă doriți să porniți un program cu funcția de temporizare, becul indicator al stării de funcționare **B** începe să clipească de îndată ce ați confirmat setarea temporizatorului. De îndată ce programul a fost pornit, becul indicator al stării de funcționare **B** va rămâne aprins.

F Greutatea pâinii

Selectarea greutății pâinii (750 g / 1000 g / 1250 g).

Apăsați în mod repetat această tastă, până ce săgeata apare sub greutatea dorită. Informațiile privind greutatea (750 g / 1000 g / 1250 g) se referă la cantitatea de ingrediente adăugate în forma de copt **7**.

INDICAȚIE

- ▶ În momentul pornirii aparatului greutatea este presetată la 1250 g. În cazul programelor 6, 7, 11 și 12 nu puteți seta greutatea pâinii.

Ⓞ Selectarea programului (meniu)

Apelarea programului de coacere dorit (1-12). Pe ecran **A** apare numărul de program și timpul de coacere corespunzător.

Funcția de memorie

În cazul unei întreruperi a alimentării cu energie electrică cu o durată de până la cca 10 minute, programul este reluat din starea în care a fost întrerupt. Acest lucru nu este însă valabil pentru ștergerea/terminarea procesului de coacere și nici în cazul apăsării tastei Pornire/Oprire **B**, până când se aude un semnal sonor lung.

Fereastra de control **1**

Prin fereastra de control **1** puteți urmări procesul de coacere.

Programe

Cu ajutorul tastei de selectare a programului **Ⓞ** este ales programul dorit. Numărul corespunzător al programului este afișat pe ecran **A**. Timpii de coacere depind de combinațiile de program selectate. A se vedea capitolul „Derularea programului”.

Programul 1: Normal

Pentru pâine albă și din amestec, în principal, din făină de grâu sau secară. Pâinea are o consistență compactă. Rumenirea pâinii se va seta cu ajutorul tastei pentru gradul de rumenire **Ⓞ**.

Programul 2: Afânată

Pentru pâini ușoare din făină bine măcinată. Pâinea este de regulă afânată și are o coajă crocantă.

Programul 3: Făină integrală

Pentru pâini din tipuri de făină integrală, de exemplu făină integrală de grâu și făină de secară. Pâinea este mai compactă și mai grea.

Programul 4: Dulce

Pentru pâini care conțin sucuri de fructe, fulgi de cocos, stafide, fructe uscate, ciocolată sau adaos de zahăr. Printr-o dospire mai lungă, pâinea va fi mai ușoară și mai aerată.

Programul 5: Expres

Este necesar un timp mai scurt pentru frământare, dospire și coacere. Totuși, cu acest program pot fi preparate numai rețetele care nu conțin ingrediente grele sau făină integrală. Se va avea în vedere faptul că pâinea nu devine atât de aerată sau gustoasă cu ajutorul acestui program.

Programul 6: Aluat (frământat)

Pentru prepararea de alături dospite pentru chifle, pizza sau împletituri. Procesul de coacere lipsește din acest program.

Programul 7: Aluat de tăiței

Pentru prepararea aluatului de tăiței. Procesul de coacere lipsește din acest program.

Programul 8: Pâine cu lapte bătut

Pentru pâinile care conțin lapte bătut sau iaurt.

Programul 9: Fără gluten

Pentru pâini din făină și amestecuri fără gluten. Făina fără gluten are nevoie de mai mult timp pentru a absorbi lichidele și are alte proprietăți de creștere.

Programul 10: Prăjituri

Cu acest program, ingredientele sunt frământate, dospite, iar apoi coapte. Folosiți praf de copt pentru acest program.

Programul 11: Dulceață

Pentru prepararea gemurilor, dulcețurilor, jeleurilor și a altor produse din fructe.

Programul 12: Coacere

Pentru recoacerea pâinilor care nu sunt suficient de rumenite sau de coapte ori pentru alături gata preparate. În cazul acestui program nu are loc niciun proces de frământat și amestecare. După terminarea programului de coacere, pâinea este păstrată caldă încă o oră. Astfel, se previne umezirea prea puternică a pâinii. Programul 12 coace pâinea timp de 60 de minute.

Pentru a încheia programul înainte de terminare, apăsați tasta Pornire/Oprire **B**, până se aude un semnal sonor lung. Pentru a opri aparatul deconectați-l de la rețeaua electrică.

INDICAȚIE

- ▶ În cazul programelor 1, 2, 3, 4, 5, 6, 8 și 9, în timpul derulării programului se aude în semnal sonor, iar pe ecran apare „ADD” (6). Imediat după aceea, adăugați și alte ingrediente, precum fructe sau nuci. Programul nu trebuie întrerupt. Ingredientele nu sunt mărunțite de către paletele de frământat (6). După setarea temporizatorului, toate ingredientele pot fi adăugate și la începutul programului în forma de copt (7). În acest caz, fructele și nucile ar trebui puțin mărunțite înainte de adăugare.

Funcția de temporizare

Această funcție vă permite setarea unui proces de coacere temporizat.

Cu ajutorul tastelor cu săgeți ▼ și ▲ (D) puteți seta ora finală dorită a procesului de coacere. Timpul maxim de temporizare este de 15 ore.

⚠ AVERTIZARE! PERICOL DE INCENDIU!

- ▶ Înainte de a coace o pâine cu funcția de temporizare, încercați mai întâi rețeta pentru a vă asigura că raportul dintre ingrediente este cel bun, că aluatul nu este prea tare sau prea moale ori cantitatea prea mare și atunci eventual ar putea să se reverse.

- 1) Selectați un program. Pe ecran (A) apare timpul de coacere necesar.
- 2) Cu ajutorul tastei cu săgeată ▲ (D) modificați sfârșitul programului. La prima acționare timpul final se modifică până la următoarele zeci. Orice apăsare a tastei cu săgeată ▲ (D) mută timpul final cu 10 minute. Dacă țineți tasta apăsată, procesul de modificare este mai rapid. Ecranul indică durata totală de coacere și timpul de temporizare. Dacă ați depășit timpul de temporizare posibil, acesta poate fi corectat cu tasta cu săgeți ▼ (D).
- 3) Confirmați setarea temporizatorului cu ajutorul tastei Pornire/Oprire (B).

Becul indicator al stării de funcționare (E) începe să clipească. Semnul cu două puncte de pe ecran (A) clipește, iar timpul programat începe să se scurgă.

De îndată ce programul a fost pornit, becul indicator al stării de funcționare (E) va rămâne aprins. La încheierea procesului de coacere se aud zece semnale sonore, iar pe ecran (A) apare 0:00.

Exemplu:

Este ora 8.00, iar dvs. doriți să aveți pâine proaspătă în 7 ore și 30 de minute, deci la ora 15:30. Selectați mai întâi programul 1, iar apoi apăsați tastele cu săgeți (D) până când pe ecran (A) apare 7:30, pentru că timpul până la finalizarea preparării este de 7 ore și 30 de minute.

INDICAȚIE

- ▶ În cazul programului „Dulceață”, funcția de temporizare nu este disponibilă.

INDICAȚIE

- ▶ Nu utilizați funcția de temporizare dacă preparați alimente cu perisabilitate ridicată, de exemplu ouă, lapte, smântână sau brânză.

Înainte de coacere

Pentru o coacere reușită se vor avea în vedere următorii factori:

Ingrediente

⚠ AVERTIZARE! PERICOL DE INCENDIU!

- ▶ Scoateți forma de copt (7) din carcasă înainte să adăugați ingredientele. Dacă ingredientele ajung în compartimentul de coacere, din cauza încălzirii rezistențelor de încălzire se pot produce incendii.
- Adăugați ingredientele în forma de copt (7) întotdeauna în ordinea indicată.
- Toate ingredientele trebuie să fie încălzite la temperatura camerei pentru asigurarea unui proces optim de dospire a drojdiei.

⚠️ AVERTIZARE! PERICOL DE INCENDIU!

- ▶ În niciun caz nu utilizați cantități mai mari decât cele indicate. Prea mult aluat poate să se reverse peste forma de copt **7** și să provoace un incendiu la rezistențele fierbinți de încălzire.
- Se va avea în vedere o măsurare exactă a cantităților de ingrediente. Chiar și mici abateri de la cantitățile indicate în rețetă pot influența rezultatul obținut.

Coacerea pâinii**Pregătirea****INDICAȚIE**

- ▶ Așezați mașina de făcut pâine pe o suprafață plană și rezistentă.

- 1) Scoateți forma de copt **7** din aparat prin partea de sus.
- 2) Montați paletele de frământat **6** pe arborii de antrenare din forma de copt **7**. Aveți grijă să fie bine fixate.
- 3) Adăugați ingredientele din rețeta dvs. în forma de copt **7**. Mai întâi introduceți ingredientele lichide, zahărul, sarea și apoi făina, iar în final drojdia.

INDICAȚIE

- ▶ Asigurați-vă că drojdia nu intră în contact cu sarea sau cu lichidele.

- 4) Introduceți la loc forma de copt **7**. Asigurați-vă că închiderea este corectă.
- 5) Închideți capacul aparatului **2**.
- 6) Introduceți ștecărul în priză. Se aude un semnal sonor, iar pe ecran **A** apare numărul programului și durata pentru programul 1.
- 7) Selectați programul cu tasta de preselectare a programelor **G**. Orice introducere se confirmă printr-un semnal sonor.
- 8) Selectați, dacă este cazul, mărimea pâinii cu ajutorul tastei **F**.

- 9) Selectați gradul de rumenire **G** al pâinii dvs. Pe ecran **A**, săgeata indică dacă ați setat gradul de rumenire pe puțin rumenit, mediu rumenit sau bine rumenit. De asemenea, puteți selecta opțiunea „Rapid” pentru a reduce timpul de dospire a aluatului.

INDICAȚIE

- ▶ Funcția „Grad de rumenire” nu este disponibilă pentru programele 6, 7 și 11. Funcția „Rapid” este disponibilă doar pentru programele 1 - 4. Pentru programele 6, 7, 11 și 12, nu este posibilă setarea greutății pâinii.

- 10) Cu ajutorul funcției de temporizare aveți posibilitatea de a seta ora de finalizare a programului. Puteți seta o temporizare maximă de 15 ore.

INDICAȚIE

- ▶ Această funcție nu este disponibilă pentru programul 11.

Pornirea programului

Porniți acum programul cu ajutorul tastei Pornire/Oprire **B**.

INDICAȚIE

- ▶ Programele 1, 2, 3, 4, 6 și 8 pornesc cu o fază de preîncălzire de 10 până la 30 de minute (cu excepția modului Rapid, a se vedea Tabelul Derularea programului). Paletele de frământat **6** nu se mișcă în acest timp. Aceasta nu reprezintă o eroare a aparatului.

Programul efectuează în mod automat diversele procese de lucru.

Puteți verifica derularea programului prin fereastra de control **1** a mașinii dvs. de făcut pâine. Se poate întâmpla ca în timpul procesului de coacere fereastra de control **1** să se aburească. În timpul frământării, capacul aparatului **2** poate fi deschis.

INDICAȚIE

- ▶ Nu deschideți capacul aparatului **2** în timpul fazei de dospire sau coacere. Pâinea se poate lăsa.

Finalizarea programului

La încheierea procesului de coacere se aud zece semnale sonore, iar pe ecran **A** apare 0:00.

La terminarea programului, aparatul comută automat în regim de menținere la cald care durează până la 60 de minute.

INDICAȚIE

- ▶ Acest lucru nu este valabil pentru programele 6, 7 și 11.

În acest timp circulă aer cald prin aparat. Funcția de menținere la cald poate fi oprită înainte de cele 60 de minute prin ținerea apăsată a tastei Pornire/Oprire **B** până în momentul în care se aud semnalele sonore.

⚠ PERICOLI ELECTROCUTARE!

- ▶ Scoateți ștecărul din priză înainte de a deschide capacul aparatului **2**. În cazul în care nu este utilizat, aparatul trebuie deconectat de la rețeaua de curent!

Scoaterea pâinii

La scoaterea pâinii din forma de copt **7** utilizați mereu lavete sau mănuși de bucătărie. Țineți forma de copt **7** înclinată deasupra unui grătar și scuturați-o ușor, până când pâinea se desprinde din forma de copt **7**.

Dacă pâinea nu poate fi desprinsă de pe paletele de frământat **6**, îndepărtați cu atenție paletele de frământat **6** folosind cârligul **10** prevăzut în acest sens.

INDICAȚIE

Nu folosiți obiecte metalice, care ar putea zgâria stratul neaderent. Spălați forma de copt **7** cu apă caldă imediat după scoaterea pâinii din ea. Acestea împiedică lipirea paletelor de frământat **6** de arborele de antrenare.

SFAT

Dacă scoateți paletele de frământat **6** după ultimul proces de frământare, pâinea nu se va rupe în momentul extragerii ei din forma de copt **7**.

- Apăsăți scurt tasta Pornire/Oprire **B**, pentru a întrerupe programul la începutul fazei de copt sau scoateți ștecărul din priză. În interval de 10 minute trebuie să introduceți ștecărul din nou în priză, pentru a putea continua programul de coacere.
- Deschideți capacul aparatului **2** și scoateți forma de copt **7**. Cu mâinile acoperite cu făină puteți scoate aluatul și îndepărta paletele de frământat **6**.
- Așezați aluatul din nou în forma de copt **7**. Introduceți din nou forma de copt **7** și închideți capacul aparatului **2**.
- Introduceți eventual ștecărul în priză. Programul de coacere este continuat.

Lăsați pâinea să se răcească timp de 15 - 30 de minute înainte de a o consuma.

Înainte de a tăia pâinea asigurați-vă întotdeauna că în aluat nu se află paletele de frământat **6**.

Mesașe de eroare

- Dacă ecranul **A** indică „HHH” după pornirea programului, temperatura mașinii de făcut pâine este încă prea ridicată. Opriți programul și scoateți ștecărul din priză. Deschideți capacul aparatului **2** și așteptați 20 de minute să se răcească aparatul înainte de a-l utiliza din nou.
- Dacă, în momentul în care mașina de făcut pâine și-a încheiat programul, nu poate fi pornit niciun program nou, înseamnă că mașina încă este prea fierbinte. În acest caz, afișajul de pe ecran revine la setarea de bază (programul 1). Deschideți capacul aparatului **2** și așteptați 20 de minute să se răcească aparatul înainte de a-l utiliza din nou.

INDICAȚIE

- ▶ Nu încercați să puneți aparatul în funcțiune înainte să se fi răcit. Aceasta funcționează doar la programul 12.

- Dacă ecranul indică „EEO”, „EE1” sau „LL” după pornirea programului, opriți mai întâi mașina de făcut pâine și apoi reporniți-o, prin extragerea și reintroducerea ștecărilor în priză. În cazul în care problema persistă, contactați serviciul clienți.

Curățarea și îngrijirea

⚠ PERICOL! ELECTROCUTARE!

- ▶ Extrageți ștecărul din priză înainte de fiecare curățare și lăsați aparatul să se răcească. Protejați aparatul împotriva umezelii, deoarece aceasta ar putea provoca electrocutări. De asemenea, respectați indicațiile de siguranță în această privință.

ATENȚIE! PAGUBE MATERIALE!

- ▶ Componentele aparatului, respectiv accesoriile nu pot fi spălate în mașina de spălat vase!
- ▶ Nu utilizați substanțe chimice sau diluanți pentru curățarea mașinii de făcut pâine.

Carcasa, capacul, compartimentul de coacere

- Îndepărtați toate resturile din compartimentul de coacere cu o lavetă umedă sau cu un burete puțin umed.
- De asemenea, ștergeți carcasa și capacul doar cu o lavetă sau burete umed. Pentru o curățare mai ușoară, capacul aparatului ② poate fi îndepărtat de pe carcasă:
 - Deschideți capacul aparatului ② până ce elementele conice de plastic intră prin orificiile ghidajelor balamalei.
 - Scoateți capacul aparatului ② din ghidajele balamalei.
 - Pentru a monta capacul aparatului ② treceți elementele de plastic prin orificiul ghidajelor balamalei.

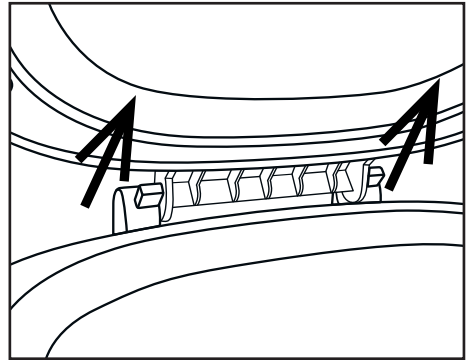

- Uscați totul bine și asigurați-vă că înainte de o nouă utilizare toate componentele sunt uscate.

Forma de copt, paletetele de frământat și accesoriile

ATENȚIE! PAGUBE MATERIALE!

- ▶ Nu introduceți forma de copt ⑦ în apă sau în alte lichide.
- ▶ Suprafețele formei de copt ⑦ și ale paletetele de frământat ⑥ sunt prevăzute cu un strat antiaderent. De aceea, la curățare, nu utilizați substanțe de curățare agresive, substanțe corozive sau obiecte care ar putea zgâria aceste suprafețe.

INDICAȚIE

- ▶ Din cauza umezelii și a aburului, aspectul suprafețelor se poate modifica cu timpul. Aceasta nu reprezintă o periclitate a funcționării și nici nu reduce calitatea produselor.
- Înainte de curățare scoateți forma de copt ⑦ și paletetele de frământat ⑥ din compartimentul de coacere.

- Scoateți paletetele de frământat **6** din forma de copt **7**. Dacă paletetele de frământat **6** nu pot fi scoase din forma de copt **7**, umpleți forma de copt **7** timp de aproximativ 30 de minute cu apă fierbinte. Paletetele de frământat **6** ar trebui să se poată desprinde acum.

Curățați paletetele de frământat **6** în apă caldă și adăugați un detergent blând. În cazul formării unor cruste uscate, lăsați paletetele de frământat **6** să se înmoaie în apa respectivă, până când se pot îndepărta cu ajutorul unei perii.

Dacă suportul din paleta de frământat **6** este înfundat, acesta se poate curăța cu grija cu ajutorul unui bețișor de lemn. După curățare uscați bine paletetele de frământat **6**.

- Ștergeți exteriorul formei de copt **7** cu ajutorul unei lavete umede.
- Curățați interiorul formei de copt **7** cu apă caldă și puțin detergent. În cazul formării unor cruste în forma de copt **7**, adăugați apă în forma de copt **7** și un detergent blând. Lăsați-o la înmuiat până când crusta poate fi curățată cu o perie. Apoi spălați forma de copt **7** cu multă apă și uscați-o bine.
- Curățați paharul gradat **8**, lingura de măsurat **9** și cârligul de extragere a paletelor de frământat **10** în apă caldă și adăugați un detergent blând. Apoi clătiți componentele cu apă curată, pentru a înlătura restul detergentului de vase. Uscați totul bine.

Eliminarea



În niciun caz nu aruncați aparatul în gunoiul menajer obișnuit. Acest produs face obiectul Directivei europene 2012/19/EU.

Eliminați produsul și toate componentele sale prin intermediul unei firme specializate sau al serviciului local de eliminare a deșeurilor.

Respectați reglementările actuale în vigoare. Dacă aveți nelămuriri, contactați serviciul local de eliminare a deșeurilor.



Eliminați toate ambalajele într-un mod ecologic.

Garanția și service-ul

Pentru acest aparat se acordă o garanție de 3 ani de la data cumpărării. Aparatul a fost produs cu grijă și verificat cu rigurozitate înaintea livrării.

Păstrați bonul de casă pentru a dovedi cumpărarea. În caz de defecțiuni în perioada de garanție, contactați telefonic centrul dvs. de service. Numai astfel poate fi asigurată o expediere gratuită a produsului dvs.

Garanția acoperă numai defectele de material sau de fabricație, nu și deteriorările rezultate în urma transportului, piesele de uzură, precum formele de copt sau paletetele de frământat sau deteriorările apărute la componentele fragile, de exemplu comutatoare sau baterii. Aparatul este destinat numai uzului privat și nu utilizărilor profesionale.

În cazul manevrării abuzive sau necorespunzătoare, al uzului de forță și al intervențiilor care nu au fost realizate de către filiala noastră autorizată de service, garanția își pierde valabilitatea. Drepturile dvs. legale nu sunt limitate prin această garanție.

Perioada de garanție nu este prelungită după efectuarea reparațiilor realizate în perioada de garanție. Acest lucru este valabil și pentru piesele înlocuite și reparate. Deteriorările și deficiențele prezente deja la cumpărare trebuie semnalate imediat după dezambalare sau cel târziu la două zile de la data cumpărării. Reparațiile necesare după expirarea perioadei de garanție se efectuează contra cost.

RO Service România

Tel.: 0800896637

E-Mail: kompernass@lidl.ro

IAN 270356

Acces linie telefonică directă:

De luni până vineri, între orele 8:00 - 20:00 (CET)

Importator

KOMPERNASS HANDELS GMBH

BURGSTRASSE 21









44867 BOCHUM

GERMANY









www.kompernass.com

RO









Derularea programului

Program	1. Normal						2. Afânată					
	Puțin rumenit Mediu rumenit Bine rumenit			Rapid			Puțin rumenit Mediu rumenit Bine rumenit			Rapid		
Dimensiune	750 g	1000 g	1250 g	750 g	1000 g	1250 g	750 g	1000 g	1250 g	750 g	1000 g	1250 g
Timp (ore)	02:58	03:05	03:15	02:14	02:20	02:25	03:13	3:18	3:25	2:18	2:25	2:30
Preîncălzire (min) 	15	15	20	N/A	N/A	N/A	10	10	15	N/A	N/A	N/A
Frământare 1 (min) 	12	13	13	12	13	13	12	12	15	12	13	13
Dospire 1 (min) 	25	25	25	10	10	10	20	20	20	10	10	10
Frământare 2 (min) 	2 3A* 5	2 5A 5	2 5A 5	2 1A 5	2 2A 5	2 2A 5	2 3A* 8	2 5A 8	2 5A 8	2 1A 5	2 2A 5	2 2A 5
Dospire 2 (min) 	30	30	30	18	18	18	43	41	35	18	18	18
Dospire 3 (min) 	30	30	30	30	30	30	35	35	35	30	30	30
Coacere (min) 	56	60	65	56	60	65	60	65	70	60	65	70
Menținere la cald (min) 	60	60	60	60	60	60	60	60	60	60	60	60
Adăugarea ingredientelor (ore rămase)	02:01	02:05	02:10	01:49	01:53	01:58	02:26	02:29	02:28	01:53	1:58	2:03
Presetarea timpului	15h	15h	15h	15h	15h	15h	15h	15h	15h	15h	15h	15h









* 3A înseamnă că după cele 3 minute de frământare se aud 10 semnale sonore și în același timp apare pe ecran „ADD” . Acest lucru vă amintește de faptul că acum puteți adăuga fructe sau nuci.

Program	3. Făină integrală						4. Dulce					
	Puțin rumenit Mediu rumenit Bine rumenit			Rapid			Puțin rumenit Mediu rumenit Bine rumenit			Rapid		
Dimensiune	750 g	1000 g	1250 g	750 g	1000 g	1250 g	750 g	1000 g	1250 g	750 g	1000 g	1250 g
Timp (ore)	3:18	3:25	3:35	2:24	2:30	2:35	2:56	3:01	3:10	2:10	2:16	2:20
Preîncălzire (min) 	15	15	20	N/A	N/A	N/A	10	10	15	N/A	N/A	N/A
Frământare 1 (min) 	11	12	12	11	13	13	12	12	12	11	12	12
Dospire 1 (min) 	30	30	30	10	10	10	25	25	25	10	10	10
Frământare 2 (min) 	2 3A 8	2 5A 8	2 5A 8	2 2A 5	2 2A 5	2 2A 5	2 4A* 6	2 5A 6	2 5A 6	2 1A 6	2 2A 6	2 2A 6
Dospire 2 (min) 	38	38	38	23	23	23	35	35	35	18	18	18
Dospire 3 (min) 	35	35	35	35	35	35	30	30	30	30	30	30
Coacere (min) 	56	60	65	56	60	65	52	56	60	52	56	60
Menținere la cald (min) 	60	60	60	60	60	60	60	60	60	60	60	60
Adăugarea ingredientelor (ore rămase)	2:17	2:21	2:26	1:59	2:03	2:08	2:03	2:07	2:11	1:46	1:50	1:54
Presetarea timpului	15h	15h	15h	15h	15h	15h	15h	15h	15h	15h	15h	15h

* 4A înseamnă că după cele 4 minute de frământare se aud 10 semnale sonore și în același timp apare pe ecran „ADD” . Acest lucru vă amintește de faptul că acum puteți adăuga fructe sau nuci.

Program	5. Expres			6. Aluat	7. Aluat de tăiței	8. Pâine cu lapte bătut			9. Fără gluten		
Grad de rumenire	Puțin rumenit Mediu rumenit Bine rumenit			N/A	N/A	Puțin rumenit Mediu rumenit Bine rumenit			Puțin rumenit Mediu rumenit Bine rumenit		
Dimensiune	750 g	1000 g	1250 g	N/A	N/A	750 g	1000 g	1250 g	750 g	1000 g	1250 g
Timp (ore)	1:15	1:18	1:20	1:50	0:15	3:17	3:21	3:30	2:14	2:20	2:25
Preîncălzire (min) 	N/A	N/A	N/A	10	N/A	25	25	30	N/A	N/A	N/A
Frământare 1 (min) 	8	8	8	12	15	10	10	10	12	13	13
Dospire 1 (min) 	N/A	N/A	N/A	10	N/A	20	20	20	10	10	10
Frământare 2 (min) 	N/A 2A 5	N/A 2A 5	N/A 2A 5	N/A 3A 5	N/A N/A N/A	2 5A* 8	2 5A* 8	2 5A* 8	2 1A 5	2 2A 5	2 2A 5
Dospire 2 (min) 	N/A	N/A	N/A	25	N/A	45	45	45	18	18	18
Dospire 3 (min) 	20	20	20	45	N/A	30	30	30	30	30	30
Coacere (min) 	40	43	45	N/A	N/A	52	56	60	56	60	65
Menținere la cald (min) 	60	60	60	N/A	N/A	60	60	60	60	60	60
Adăugarea ingredientelor (ore rămase)	1:05	1:08	1:10	1:15	N/A	2:15	2:19	2:23	1:49	1:53	1:58
Presetarea timpului	15h	15h	15h	15h	15h	15h	15h	15h	15h	15h	15h

* 5A înseamnă că după cele 5 minute de frământare se aud 10 semnale sonore și în același timp apare pe ecran „ADD” . Acest lucru vă amintește de faptul că acum puteți adăuga fructe sau nuci.

Program	10. Prăjituri			11. Dulceață	12. Coacere
Grad de rumenire	Puțin rumenit Mediu rumenit Bine rumenit			N/A	Puțin rumenit Mediu rumenit Bine rumenit
Dimensiune	750 g	1000 g	1250 g	N/A	N/A
Timp (ore)	1:30	1:35	1:40	1:20	1:00
Preîncălzire (min) 	N/A	N/A	N/A	N/A	N/A
Frământare 1 (min) 	15	15	15	N/A	N/A
Dospire 1 (min) 	N/A	N/A	N/A	15 Încălzire + frământare	N/A
Frământare 2 (min) 	N/A N/A N/A	N/A N/A N/A	N/A N/A N/A	N/A N/A N/A	N/A N/A N/A
Dospire 2 (min) 	N/A	N/A	N/A	N/A	N/A
Dospire 3 (min) 	N/A	N/A	N/A	45 Încălzire + frământare	N/A
Coacere (min) 	60	65	70	20 Dospire	60
	15 Dospire	15 Dospire	15 Dospire		
Menținere la cald (min) 	60	60	60	N/A	60
Adăugarea ingredientelor (ore rămase)	N/A	N/A	N/A	N/A	N/A
Presetarea timpului	15h	15h	15h	N/A	15h

Remediarea defecțiunilor de la mașina de făcut pâine

Ce trebuie făcut dacă paletele de frământat 6 rămân blocate după coacere în forma de copt 7 ?	Turnați apă fierbinte în forma de copt 7 și rotiți paleta de frământat 6 pentru a desprinde crustele uscate de dedesubt.
Ce se întâmplă dacă pâinea rămâne în mașina de făcut pâine după ce a fost preparată?	Cu „Funcția de menținere la cald” se asigură că pâinea se păstrează caldă cca.1 oră și că este protejată de umezeală. Pâinea se poate umezi, dacă rămâne în aparat mai mult de o oră.
Forma de copt 7 și paletele de frământat 6 pot fi spălate în mașina de spălat vase?	Nu. Spălați manual forma de copt 7 și paletele de frământat 6 .
De ce nu este amestecat aluatul, deși motorul funcționează?	Verificați dacă paletele de frământat 6 și forma de copt 7 sunt bine înclchetate.
Ce trebuie făcut dacă paleta de frământat 6 rămâne blocată în pâine?	Îndepărtați paleta de frământat 6 cu ajutorul cârligului 10 .
Ce se întâmplă în caz de întrerupere a alimentării cu energie electrică în timp ce se execută un program?	În caz de întrerupere a alimentării cu energie electrică de până la 10 minute, mașina de făcut pâine va executa până la sfârșit ultimul program.
Cât durează coacerea pâinii?	Consultați timpii exacti în tabelul „Derularea programului”.
Care sunt greutatele de pâine pe care le pot prepara?	Puteți coace pâini de 750 g - 1000 g - 1250 g.
De ce nu poate fi folosită funcția de temporizare la coacerea cu lapte proaspăt?	Produsele proaspete cum ar fi laptele sau ouăle se strică dacă rămân prea mult timp în aparat.
Ce se întâmplă dacă mașina de făcut pâine nu funcționează, chiar și după apăsarea tastei Pornire/Oprire B ?	Unele etape de lucru, de exemplu, „Încălzirea” sau „Repaus” sunt greu de recunoscut. Cu ajutorul tabelului „Derularea programului” puteți verifica ce parte din program se desfășoară într-un anumit moment. Verificați dacă aparatul funcționează, prin controlarea becului indicator al stării de funcționare E . Verificați dacă ați apăsat corect tasta Pornire/Oprire B . Verificați dacă este introdus ștecărul în priză.
Aparatul toacă stafidele adăugate.	Pentru a evita mărunțirea ingredientelor precum fructe sau nuci, adăugați-le în aluat numai după ce se aude semnalul sonor.



TALON DE COMANDĂ SBB 850 C1

► www.kompernass.com

CANTITATE

(max. 3 seturi/comandă)

DENUMIRE ARTICOL

PREȚ UNITAR

TOTAL

- 1 formă de coacere inclusiv 2 cârlige de frământat



43,- RON



RON

+

sunt incluse taxele
poștale, taxa ramburs,
costurile pentru ambalaj și
expedijie.

23,- RON

(inclusiv 24% Vat)

- 4 cârlige de frământat



43,- RON



RON

+

sunt incluse taxele
poștale, taxa ramburs,
costurile pentru ambalaj și
expedijie.

15,- RON

(inclusiv 24% Vat)

- Indicație: În cazul în care comanda dvs. conține mai multe articole (setul de 4 cârlige pentru aluat și forma de copt), veți achita întotdeauna prețul de expediere mai ridicat de 23,- RON!

(Localitatea, data)

(Semnătura)

= _____ RON

MODALITATEA DE PLATĂ

Plata ramburs

TALON DE COMANDĂ SBB 850 C1

► www.komperrass.com



1) La rubrica „expeditor/persoana care comandă” treceți numele dvs., adresa și numărul de telefon (pentru eventuale întrebări) cu litere majuscule.

2) Apoi, expediați talonul completat integral, într-un plic, la următoarea adresă poștală:

Transilvania Service Group SRL

Calea Turzii Nr. 231 - 233

RO - 400459 Cluj Napoca

IMPORTANT

- Lipiți un număr suficient de timbre pe plic.
- Pe plic, la rubrica expeditor, scrieți numele dumneavoastră.

3) Comanda va fi expediată ca și colet cu plata ramburs.

**EXPEDITOR / PERSOANA CARE
COMANDĂ**

(a se completa cu MAJUSCULE)

Nume, prenume

Strada

Cod poștal/localitate

Telefon

Περιεχόμενα

Εισαγωγή.....	66
Προβλεπόμενη χρήση	66
Παραδοτέος εξοπλισμός	66
Περιγραφή συσκευής	66
Τεχνικά χαρακτηριστικά.....	66
Υποδείξεις ασφαλείας.....	67
Πριν την πρώτη χρήση.....	71
Ιδιότητες.....	71
Πεδίο χειρισμού	71
Προγράμματα	73
Λειτουργία χρονοδιακόπτη	74
Πριν από το ψήσιμο	75
Ψήσιμο ψωμιού.....	75
Καθαρισμός και φροντίδα	77
Απόρριψη	78
Εγγύηση και σέρβις	79
Εισαγωγέας	79
Διαδικασία προγράμματος	80
Διόρθωση σφαλμάτων αρτοπαρασκευαστή.....	84

ΑΡΤΟΠΑΡΑΣΚΕΥΑΣΤΗΣ

Εισαγωγή

Συγχαρητήρια για την αγορά της νέας σας συσκευής.

Αποφασίσατε έτσι για την απόκτηση ενός προϊόντος υψηλής ποιότητας. Οι οδηγίες χρήσης είναι τμήμα αυτού του προϊόντος. Περιέχουν σημαντικές υποδείξεις για την ασφάλεια, τη χρήση και την απόρριψη. Πριν από τη χρήση του προϊόντος, εξοικειωθείτε με όλες τις υποδείξεις χειρισμού και ασφάλειας. Χρησιμοποιείτε το προϊόν μόνο όπως περιγράφεται και για τους αναφερόμενους τομείς χρήσης. Παραδώστε όλα τα έγγραφα σε περίπτωση παράδοσης του προϊόντος σε τρίτους.

Προβλεπόμενη χρήση

Χρησιμοποιείτε τον αρτοποιαστή μόνο για το ψήσιμο ψωμιού και για την παρασκευή μαρμελάδων για οικιακή χρήση.

Μη χρησιμοποιείτε τη συσκευή για το στέγνωμα τροφίμων ή αντικειμένων. Μη χρησιμοποιείτε τον αρτοποιαστή σε εξωτερικούς χώρους.

Χρησιμοποιείτε μόνο εξαρτήματα που έχουν προταθεί από τον κατασκευαστή. Μη προτεινόμενα εξαρτήματα μπορούν να φθείρουν τη συσκευή. Αυτή η συσκευή προορίζεται αποκλειστικά για χρήση σε νοικοκυριά.

Μη χρησιμοποιείτε τη συσκευή για επαγγελματικούς σκοπούς!

Παραδοτέος εξοπλισμός

Αρτοποιαστικής

Φόρμα ψήσιματος

2 Άγκιστρα ζυμώματος

Δοχείο μέτρησης

Κουτάλι μέτρησης

Εργαλείο απομάκρυνσης άγκιστρου ζυμώματος

Οδηγίες χρήσης

Σύντομες πληροφορίες

Βιβλίο συνταγών

ΥΠΟΔΕΙΞΗ

- ▶ Ελέγξτε τη συσκευή μετά την αποσυσκευασία για την πληρότητα και για ζημιές από τη μεταφορά. Εάν απαιτείται απευθυνθείτε στο τμήμα Σέρβις (δείτε το Κεφάλαιο "Εγγύηση και Σέρβις").

Περιγραφή συσκευής

Εικόνα Α:

- 1 Παράθυρο παρακολούθησης
- 2 Καπάκι συσκευής
- 3 Εγκοπή αερισμού
- 4 Καλώδιο δικτύου
- 5 Πεδίο χειρισμού

Εικόνα Β:

- 6 2 Άγκιστρα ζυμώματος
- 7 Φόρμα ψήσιματος έως 1250 g βάρους ψωμιού
- 8 Δοχείο μέτρησης
- 9 Κουτάλι μέτρησης
- 10 Εργαλείο απομάκρυνσης άγκιστρου ζυμώματος

Τεχνικά χαρακτηριστικά

Ονομαστική τάση: 220 - 240 V ~ / 50 Hz

Απορρόφηση ισχύος: 850 Watt

Υποδείξεις ασφαλείας

- ▶ Διαβάστε πρώτα καλά τις οδηγίες χρήσης, προτού χρησιμοποιήσετε τη συσκευή!

⚠ ΚΙΝΔΥΝΟΣ - ΗΛΕΚΤΡΟΠΛΗΞΙΑ!

- ▶ Ελέγχετε πριν από κάθε χρήση το καλώδιο δικτύου και το βύσμα. Όταν το καλώδιο δικτύου αυτής της συσκευής παρουσιάζει βλάβη, πρέπει να αντικατασταθεί από τον κατασκευαστή, το τμήμα εξυπηρέτησης πελατών ή ένα αντιστοίχως εξειδικευμένο άτομο, ώστε να αποφεύγετε κινδύνους.
- ▶ Μην τοποθετείτε το καλώδιο δικτύου επάνω σε αιχμηρές ακμές ή κοντά σε καυτές επιφάνειες ή αντικείμενα. Η μόνωση του καλωδίου μπορεί να καταστραφεί.
- ▶ Σε περίπτωση μη χρήσης και πριν από κάθε καθαρισμό τραβάτε το βύσμα της συσκευής από την πρίζα.
- ▶ Μην βυθίζετε τον αρτοπαρασκευαστή σε νερό ή άλλα υγρά. Υπάρχει κίνδυνος ηλεκτροπληξίας!
- ▶ Μην καθαρίζετε τη συσκευή με συρμάτινα σφουγγάρια. Εάν αποκοπούν κομμάτια του σφουγγαριού και έρθουν σε επαφή με ηλεκτρικά τμήματα, υπάρχει κίνδυνος ηλεκτροπληξίας.

⚠ ΠΡΟΕΙΔΟΠΟΙΗΣΗ! ΚΙΝΔΥΝΟΣ ΤΡΑΥΜΑΤΙΣΜΟΥ!

- ▶ Κίνδυνος ασφυξίας! Τα παιδιά μπορούν να πάθουν ασφυξία σε περίπτωση ακατάλληλης χρήσης του υλικού συσκευασίας. Απομακρύνετε το αμέσως μετά την αποσυσκευασία ή φυλάξτε το σε μέρος μη προσβάσιμο στα παιδιά.
- ▶ Προς αποφυγή κινδύνου να σκοντάψετε ή ατυχήματος, η συσκευή είναι εξοπλισμένη με ένα κοντό καλώδιο δικτύου.
- ▶ Αφήστε τη συσκευή να κρυώσει και τραβήξτε το βύσμα προτού απομακρύνετε ή τοποθετήσετε τμήματα των αξεσουάρ.
- ▶ Τοποθετείτε ένα καλώδιο επέκτασης κατά τέτοιο τρόπο, ώστε κανείς να μην μπορεί να σκοντάψει εκεί και να το τραβήξει κατά λάθος.

⚠ ΠΡΟΕΙΔΟΠΟΙΗΣΗ! ΚΙΝΔΥΝΟΣ ΤΡΑΥΜΑΤΙΣΜΟΥ!

- ▶ Όταν βρίσκονται παιδιά κοντά, επιτηρείτε καλά τη συσκευή! Όταν η συσκευή δεν χρησιμοποιείται, καθώς και πριν από τον καθαρισμό, αποσυνδέετε το βύσμα. Πριν από την απομάκρυνση μεμονωμένων εξαρτημάτων αφήνετε τη συσκευή να κρυώνει.
- ▶ Αυτή η συσκευή μπορεί να χρησιμοποιείται από παιδιά άνω των 8 ετών, καθώς και από άτομα με μειωμένες φυσικές, αισθητηριακές ή νοητικές δυνατότητες ή ελλείψεις σε εμπειρία και/ή γνώσεις, εφόσον επιτηρούνται ή έχουν εκπαιδευτεί αναφορικά με την ασφαλή χρήση της συσκευής και έχουν κατανοήσει τους προκύπτοντες κινδύνους.
- ▶ Τα παιδιά δεν επιτρέπεται να παίζουν με την συσκευή.
- ▶ Ο καθαρισμός και η συντήρηση χρήστη δεν επιτρέπεται να διεξάγονται από παιδιά, εκτός εάν είναι μεγαλύτερα των 8 ετών και επιτηρούνται.
- ▶ Παιδιά κάτω των 8 ετών πρέπει να παραμένουν μακριά από τη συσκευή και το καλώδιο σύνδεσης.
- ▶ Αυτή η συσκευή πληροί τους σχετικούς κανονισμούς ασφαλείας. Ο έλεγχος, η επισκευή και η τεχνική συντήρηση επιτρέπεται να διεξάγονται μόνο από εξειδικευμένο έμπορο. Σε άλλη περίπτωση ακυρώνεται η απαίτηση εγγύησης.
- ▶ Προσοχή! Ο αρτοπαρασκευαστής υπερθερμαίνεται. Πιάνετε τη συσκευή μόνο εάν έχει κρυώσει ή χρησιμοποιείτε ένα πανί κουζίνας.
- ▶ Μην μετακινείτε τον αρτοπαρασκευαστή εάν υπάρχει μέσα στην φόρμα καυτό ή υγρό περιεχόμενο, π.χ. μαρμελάδες. Υπάρχει κίνδυνος εγκαύματος!
- ▶ Κατά τη διάρκεια της χρήσης μην πιάνετε τα περιστρεφόμενα άγκιστρα ζυμώνματος. Υπάρχει κίνδυνος τραυματισμού!
- ▶ Κατά τη διάρκεια της χρήσης μπορεί η θερμοκρασία της επιφάνειας επαφής να είναι πολύ υψηλή. Κίνδυνος εγκαύματος!



Προσοχή! Καυτή επιφάνεια!

Μέρη της συσκευής υπερθερμαίνονται κατά την λειτουργία!

Κίνδυνος εγκαύματος!

⚠ ΠΡΟΕΙΔΟΠΟΙΗΣΗ! ΚΙΝΔΥΝΟΣ ΠΥΡΚΑΓΙΑΣ!

- ▶ Μη χρησιμοποιείτε εξωτερικό χρονοδιακόπτη ή ξεχωριστό τηλεχειριστήριο για να λειτουργήσετε τη συσκευή.
- ▶ Μην τοποθετείτε τη συσκευή κοντά σε εύφλεκτα υλικά, εκρηκτικά και/ή εύφλεκτα αέρια. Πρέπει να τηρείται μια ελάχιστη απόσταση 10 εκ. προς άλλα αντικείμενα.
- ▶ Ποτέ μην καλύπτετε τη συσκευή με πετσέτα ή άλλα υλικά. Η θερμότητα και ο ατμός πρέπει να μπορούν να διαφεύγουν. Μπορεί να προκληθεί πυρκαγιά εάν η συσκευή καλύπτεται ή έρχεται σε επαφή με εύφλεκτο υλικό, όπως π.χ. με κουρτίνες.
- ▶ Μην τοποθετείτε αντικείμενα επάνω στη συσκευή και μην την καλύπτετε.
- ▶ Ποτέ μην τοποθετείτε αλουμινόχαρτο ή άλλα μεταλλικά αντικείμενα στον αρτοπαρασκευαστή. Αυτό μπορεί να οδηγήσει σε βραχυκύκλωμα.
- ▶ Κατά το ψήσιμο μην υπερβαίνετε ποτέ την ποσότητα των 700 g αλεύρι και ποτέ μην προσθέτετε περισσότερο από 1 ¼ πακέτο ξηρή μαγιά. Η ζύμη μπορεί να υπερχειλίσει και να προκαλέσει πυρκαγιά! Εξαιρούνται τα ψωμιά χωρίς γλουτένη. Σε αυτή την περίπτωση επιτρέπεται να προστίθενται το μέγιστο έως 2 πακέτα ξηρή μαγιά (Βλ. το βιβλίο συνταγών).

ΠΡΟΣΟΧΗ – ΥΛΙΚΕΣ ΖΗΜΙΕΣ!

- ▶ Προσέξτε ώστε να μην καλύπτονται οι οπές αερισμού της συσκευής. Κίνδυνος υπερθέρμανσης!
- ▶ Ποτέ μην αφήνετε τη συσκευή ανεπιτήρητη κατά τη λειτουργία!
- ▶ Χρησιμοποιείτε τη συσκευή μόνο σε εσωτερικούς χώρους.
- ▶ Ποτέ μην τοποθετείτε τη συσκευή επάνω ή δίπλα σε μάτια αερίου ή ηλεκτρικά μάτια, σε καυτό φούρνο ή άλλες πηγές θερμότητας. Κίνδυνος υπερθέρμανσης!
- ▶ Η χρήση μη προτεινόμενων από τον κατασκευαστή αξεσουάρ μπορεί να οδηγήσει σε ζημιές. Χρησιμοποιείτε τη συσκευή μόνο για τον προβλεπόμενο σκοπό. Σε άλλη περίπτωση ακυρώνεται η απαίτηση εγγύησης.

ΠΡΟΣΟΧΗ – ΥΛΙΚΕΣ ΖΗΜΙΕΣ!

- ▶ Εκκινείτε ένα πρόγραμμα ψησίματος μόνο με τοποθετημένη φόρμα. Αλλιώς ίσως συμβούν ανεπανόρθωτες βλάβες στη συσκευή.
- ▶ Μην τραβάτε το βύσμα από την πρίζα, κρατώντας από το καλώδιο δικτύου.
- ▶ Μη χρησιμοποιείτε τον αρτοπαρασκευαστή για να φυλάτε τρόφιμα ή εργαλεία.
- ▶ Ποτέ μη χρησιμοποιείτε τη συσκευή με άδεια φόρμα ή χωρίς φόρμα ψησίματος. Κάτι τέτοιο προκαλεί ανεπανόρθωτες βλάβες στη συσκευή.
- ▶ Κατά τη λειτουργία κλείνετε πάντα το κάλυμμα.
- ▶ Ποτέ μην απομακρύνετε τη φόρμα ψησίματος κατά τη λειτουργία.
- ▶ Τοποθετείτε τη συσκευή μόνο επάνω σε μια στεγνή, επίπεδη και όχι ευαίσθητη σε υψηλές θερμοκρασίες επιφάνεια.
- ▶ Ελέγχετε πριν από τη σύνδεση εάν το είδος ρεύματος και η τάση δικτύου συμφωνούν με τα στοιχεία στην πινακίδα τύπου.
- ▶ Εάν χρησιμοποιείτε καλώδιο προέκτασης, τότε πρέπει η μέγιστη επιτρεπόμενη απόδοση του καλωδίου να αντιστοιχεί με αυτήν του αρτοπαρασκευαστή.

Πριν την πρώτη χρήση

Αποσυσκευασία

- Αποσυσκευάστε τη συσκευή και αφαιρέστε όλο το υλικό συσκευασίας, καθώς και τυχόν αυτοκόλλητα και προστατευτικές μεμβράνες.
- Ελέγξτε τη συσκευή μετά την αποσυσκευασία για την πληρότητα και για ζημιές από τη μεταφορά. Εάν απαιτείται απευθυνθείτε στο τμήμα Σέρβις (δείτε το Κεφάλαιο "Εγγύηση και Σέρβις").

Πρώτος καθαρισμός

Πριν από τη θέση σε λειτουργία σκουπίστε τη φόρμα ψησίματος **7**, τα άγκιστρα ζυμώνματος **6** και την εξωτερική επιφάνεια του αρτοποιασκευαστή με ένα καθαρό, νωπό πανί. Μη χρησιμοποιείτε συρμάτινα σφουγγάρια καθαρισμού ή τριβικά μέσα. Απομακρύνετε, εφόσον δεν έχει γίνει ακόμα, την προστατευτική μεμβράνη από το πεδίο χειρισμού **5**.

Πρώτο ζέσταμα

- 1) Μόνο κατά το πρώτο ζέσταμα τοποθετήστε την άδεια φόρμα ψησίματος **7** μέσα στη συσκευή και κλείστε το καπάκι της συσκευής **2**.

⚠️ ΠΡΟΕΙΔΟΠΟΙΗΣΗ! ΚΙΝΔΥΝΟΣ ΠΥΡΚΑΓΙΑΣ!

► Μην αφήσετε τον αρτοποιασκευαστή να ζεσταθεί για περισσότερο από 5 λεπτά με την άδεια φόρμα ψησίματος **7**. Υπάρχει κίνδυνος υπερθέρμανσης.

- 2) Επιλέξτε το πρόγραμμα 12, όπως περιγράφεται στο κεφάλαιο "Προγράμματα", και πιέστε το πλήκτρο Έναρξη/Διακοπή **B** για να ζεστανέτε τη συσκευή για 5 λεπτά.
- 3) Πιέστε μετά από 5 λεπτά το πλήκτρο Έναρξη/Διακοπή **B**, έως ότου ακουστεί ένα μακρύ ηχητικό σήμα, ώστε να τερματίσετε το πρόγραμμα.

ΥΠΟΔΕΙΞΗ

Επειδή τα στοιχεία θέρμανσης έχουν ελαφρώς επαλειφτεί με λίπος, μπορεί κατά την πρώτη θέση σε λειτουργία να έχουμε μία οσμή. Αυτή δεν είναι βλαβερή και κρατά για ελάχιστο χρόνο. Φροντίστε για επαρκή αερισμό, για παράδειγμα ανοίξτε ένα παράθυρο.

- 4) Αφήστε τη συσκευή να κρυώσει εντελώς και σκουπίστε άλλη μια φορά τη φόρμα ψησίματος **7**, τα άγκιστρα ζυμώνματος **6** και την εξωτερική επιφάνεια του αρτοποιασκευαστή με ένα καθαρό, νωπό πανί.

Ιδιότητες

Με τον αρτοποιασκευαστή έχετε τη δυνατότητα να ψήσετε ψωμί σύμφωνα με το γούστο σας.



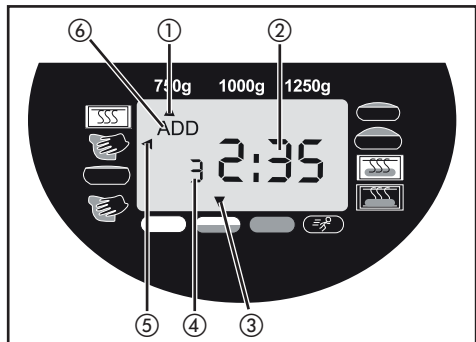
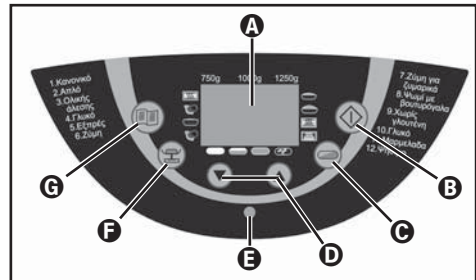

- Μπορείτε να επιλέξετε μεταξύ 12 διαφορετικών προγραμμάτων.
- Μπορείτε να επεξεργαστείτε έτοιμα μίγματα ψησίματος.
- Μπορείτε να ζυμώνετε ζύμη για ζυμαρικά ή για ψωμί ή να φτιάξετε μαρμελάδα.
- Μέσω του προγράμματος "Χωρίς γλουτένη" μπορείτε να ψήσετε μίγματα ψησίματος χωρίς γλουτένη και να κάνετε συνταγές με αλεύρι χωρίς γλουτένη, όπως π.χ. καλαμποκάλευρο, αλεύρι φαγόπυρου και αλεύρι πατάτας.

Πεδίο χειρισμού



A Οθόνη

Ένδειξη για

- ① την επιλογή του βάρους (750 g, 1000 g, 1250 g)
- ② το χρόνο λειτουργίας που απέμεινε σε ώρες και την προγραμματισμένη προεπιλογή χρόνου
- ③ τον επιλεγμένο βαθμό ροδίσματος (Ανοιχτόχρωμο , Μέτριο , Σκουρόχρωμο , Γρήγορο )
- ④ τον επιλεγμένο αριθμό προγράμματος
- ⑤ τη διαδικασία προγράμματος
- ⑥ την προσθήκη υλικών („ADD“)

B Έναρξη/Διακοπή

Για την εκκίνηση και τον τερματισμό της λειτουργίας ή για τη διαγραφή ενός προγραμματισμού χρονοδιακόπτη.

Για να σταματήσετε τη λειτουργία, πιέστε για λίγο το πλήκτρο Έναρξη/Διακοπή **B**, έως ότου ακουστεί ένα ηχητικό σήμα και αναβοσβήνει ο χρόνος στην οθόνη **A**. Πιέζοντας εκ νέου το πλήκτρο Έναρξη/Διακοπή **B** μπορεί να συνεχιστεί πάλι η λειτουργία εντός 10 λεπτών. Εάν ξεχάσετε να συνεχίσετε το πρόγραμμα, αυτό συνεχίζεται αυτόματα μετά από 10 λεπτά.

Για να τερματίσετε εντελώς τη λειτουργία ή για να διαγράψετε τις ρυθμίσεις, πιέστε για 3 δευτερόλεπτα το πλήκτρο Έναρξη/Διακοπή **B**, έως ότου ακουστεί ένα μακρύ ηχητικό σήμα.

ΥΠΟΔΕΙΞΗ

- ▶ Μην πιέσετε το πλήκτρο Έναρξη/Διακοπή **B** εάν θέλετε απλά να ελέγξετε την κατάσταση του ψωμιού. Μέσω του παραθύρου παρακολούθησης **1** μπορείτε να παρακολουθείτε τη διαδικασία ψησίματος.

ΠΡΟΣΟΧΗ!

- ▶ Κατά την πίεση όλων των πλήκτρων ακούγεται ένα ηχητικό σήμα, εκτός εάν η συσκευή είναι σε λειτουργία.

C Βαθμός ροδίσματος (ή γρήγορη λειτουργία)

Επιλογή του βαθμού ροδίσματος ή αλλαγή σε γρήγορη λειτουργία (Ανοιχτόχρωμο/Μέτριο/Σκουρόχρωμο/Γρήγορο). Πιέστε επανειλημμένα το πλήκτρο βαθμού ροδίσματος **C**, έως ότου το βέλος εμφανιστεί πάνω από τον επιθυμητό βαθμό ροδίσματος. Για τα προγράμματα ψησίματος 1 - 4 μπορείτε μέσω πολλαπλού πατήματος του πλήκτρου βαθμού ροδίσματος **C** να ενεργοποιήσετε τη γρήγορη λειτουργία, ώστε να μικρύνετε τη διαδικασία ψησίματος. Πιέστε το πλήκτρο βαθμού ροδίσματος **C** τόσες φορές, έως ότου το βέλος εμφανιστεί πάνω από το σύμβολο „Γρήγορο“. Στα προγράμματα 6, 7 και 11 δεν μπορεί να επιλεγεί βαθμός ροδίσματος.

D Χρονοδιακόπτης

Ψήσιμο με χρονοκαθυστερήση.

ΥΠΟΔΕΙΞΗ

E Λυχνία ένδειξης λειτουργίας

Η λυχνία ένδειξης λειτουργίας **E** υποδηλώνει με τη λυχνία της ότι είναι σε λειτουργία ένα πρόγραμμα. Εάν θέλετε να εκκινήσετε με χρονοκαθυστερήση ένα πρόγραμμα με τη λειτουργία χρονοδιακόπτη, αναβοσβήνει η λυχνία ένδειξης λειτουργίας **E**, μόλις επιβεβαιώσετε τη ρύθμιση του χρονοδιακόπτη. Μόλις το πρόγραμμα ξεκινήσει, ανάβει η λυχνία ένδειξης λειτουργίας **E** συνεχώς.

F Βάρος ψωμιού

Επιλογή του βάρους ψωμιού (750 g / 1000 g / 1250 g). Πιέστε αυτό το πλήκτρο επανειλημμένα, έως ότου το βέλος εμφανιστεί κάτω από το επιθυμητό βάρος. Τα στοιχεία βαρών (750 g / 1000 g / 1250 g) αναφέρονται στην ποσότητα των γεμισμένων υλικών στη φόρμα ψησίματος **7**.

ΥΠΟΔΕΙΞΗ

- ▶ Η προϋθμια κατά την ενεργοποίηση της συσκευής είναι 1250 g. Στα προγράμματα 6, 7, 11 και 12 δεν μπορείτε να ρυθμίσετε το βάρος ψωμιού.

ⓐ Επιλογή προγράμματος (Μενού)

Κλήση του επιθυμητού προγράμματος ψησίματος (1-12). Στην οθόνη **Ⓐ** εμφανίζεται ο αριθμός προγράμματος και ο αντίστοιχος χρόνος ψησίματος.

Λειτουργία μνήμης

Κατά την επανεκκίνηση μετά από μία διακοπή ρεύματος μέχρι και για 10 λεπτά, το πρόγραμμα συνεχίζει από την ίδια θέση. Αυτό δεν ισχύει ωστόσο για τη(-ον) Διαγραφή/Τερματισμό της διαδικασίας ψησίματος ή σε πάτημα του πλήκτρου Έναρξη/ Διακοπή **ⓑ** έως ότου ακουστεί ένα μακρύ ηχητικό σήμα.

Παράθυρο παρακολούθησης **ⓑ**

Με αυτό το παράθυρο παρακολούθησης **ⓑ** μπορείτε να παρακολουθείτε την διαδικασία ψησίματος.

Προγράμματα

Με το πλήκτρο Επιλογή προγράμματος **ⓐ** επιλέζετε το επιθυμητό πρόγραμμα. Ο αντίστοιχος αριθμός προγράμματος θα εμφανιστεί στην οθόνη **Ⓐ**. Οι χρόνοι ψησίματος εξαρτώνται από τους επιλεγμένους συνδυασμούς προγραμμάτων. Βλέπε Κεφάλαιο „Διαδικασία προγράμματος“.

Πρόγραμμα 1: Κανονικό

Για άσπρο και ανάμεικτο ψωμί που αποτελείται κυρίως από άλευρο σίτου ή σίκαλης. Το ψωμί έχει μια συμπαγή πυκνότητα. Το ρόδισμα του ψωμιού ρυθμίζεται με το πλήκτρο βαθμού ροδίσματος **Ⓒ**.

Πρόγραμμα 2: Απλό

Για ελαφριά ψωμιά από καλά αλεσμένο αλεύρι. Το ψωμί είναι κατά κανόνα ελαφρύ και έχει μια τραγανή κρούστα.

Πρόγραμμα 3: Ολικής άλεσης

Για ψωμιά με πιο δυνατά είδη αλευριού, π.χ. αλεύρι ολικής άλεσης σίτου και αλεύρι σίκαλης. Το ψωμί γίνεται πιο συμπαγές και βαρύτερο.

Πρόγραμμα 4: Γλυκό

Για ψωμιά με συστατικά όπως χυμοί φρούτων, νιφάδες καρύδας, σταφίδες, αποξηραμένα φρούτα, σοκολάτα ή επιπλέον ζάχαρη. Μέσω μιας μεγαλύτερης φάσης φουσκώματος, το ψωμί γίνεται ελαφρύτερο και περισσότερο ανάλαφρο.

Πρόγραμμα 5: Εξπρές

Για το ζύωμα, αφήστε τη ζύμη να φουσκώσει και για το ψήσιμο χρειάζεται λιγότερος χρόνος. Για αυτό το πρόγραμμα είναι κατάλληλες συνταγές που δεν έχουν βαριά συστατικά ή δυνατά είδη αλευριού. Το ψωμί σε αυτό το πρόγραμμα μπορεί να έχει λιγότερο αέρα και να μην είναι τόσο νόστιμο.

Πρόγραμμα 6: Ζύμη (ζύωμα)

Για την παραγωγή μαγιάς μπίρας για ψωμάκια, πίτσα ή πλεξούδες. Η διαδικασία ψησίματος παραλείπεται σε αυτό το πρόγραμμα.

Πρόγραμμα 7: Ζύμη για ζυμαρικά

Για την ετοιμασία ζύμης ζυμαρικών. Η διαδικασία ψησίματος παραλείπεται σε αυτό το πρόγραμμα.

Πρόγραμμα 8: Ψωμί με βουτυρόγαλα

Για ψωμιά, τα οποία φτιάχνονται από βουτυρόγαλα ή γιαούρτι.

Πρόγραμμα 9: Χωρίς γλουτένη

Για ψωμιά από αλεύρια και μίγματα ψησίματος χωρίς γλουτένη. Τα αλεύρια χωρίς γλουτένη χρειάζονται περισσότερο χρόνο για την απορρόφηση των υγρών και για το φούσκωμα.

Πρόγραμμα 10: Γλυκό

Τα υλικά ζυμώνονται, φουσκώνουν και ψήνονται σε αυτό το πρόγραμμα. Για αυτό το πρόγραμμα χρησιμοποιήστε μπέικιν πάουτερ.

Πρόγραμμα 11: Μαρμελάδα

Για τη δημιουργία μαρμελάδων, ζελέ και προϊόντων επάλειψης από φρούτα.

Πρόγραμμα 12: Ψήσιμο

Για συμπληρωματικό ψήσιμο ψωμιών, τα οποία είναι πολύ ανοιχτόχρωμα ή δεν έχουν ψηθεί εντελώς ή για έτοιμες ζύμες. Παραλείπονται όλες οι διαδικασίες ζυμώματος ή κατάστασης ηρεμίας σε αυτό το πρόγραμμα. Το ψωμί διατηρείται ζεστό έως και μια ώρα μετά το τέλος της διαδικασίας ψησίματος. Έτσι το ψωμί δεν έχει πολύ υγρασία. Το πρόγραμμα 12 ψήνει το ψωμί για 60 λεπτά.

Για να τερματίσετε πρόωρα αυτές τις λειτουργίες, πιάστε το πλήκτρο Έναρξη/Διακοπή **B**, έως ότου ακουστεί ένα μακρύ ηχητικό σήμα. Για να απενεργοποιηθεί η συσκευή, απουσνδέστε την από το δίκτυο ρεύματος.

ΥΠΟΔΕΙΞΗ

- ▶ Στα προγράμματα 1, 2, 3, 4, 5, 6, 8 και 9 ακούγεται κατά τη διάρκεια του προγράμματος ένα ηχητικό σήμα και το σύμβολο „ADD“ **6** εμφανίζεται στην οθόνη. Αμέσως μετά προσθέστε περαιτέρω υλικά, όπως φρούτα ή καρύδια. Δεν θα πρέπει να διακόψετε το πρόγραμμα.

Τα συστατικά δεν κομματιάζονται από το άγκιστρο ζυμώνματος **6**. Εάν έχετε ρυθμίσει το χρονοδιακόπτη, μπορείτε να βάλετε όλα τα συστατικά στην αρχή του προγράμματος στη φόρμα ψησίματος **7**. Σε αυτή την περίπτωση πρέπει να ψιλοκόψετε κάπως τα φρούτα και τα καρύδια πριν από την προσθήκη.

Λειτουργία χρονοδιακόπτη

Η λειτουργία χρονοδιακόπτη σας διευκολύνει να διεξάγετε ένα επιβραδυνόμενο χρονικά ψήσιμο.

Με τα πλήκτρα με βέλη **▼** και **▲ D** ρυθμίστε την επιθυμητή τελική χρονική στιγμή της διαδικασίας ψησίματος. Η μέγιστη χρονοκαθυστερήση ανέρχεται στις 15 ώρες.

⚠ ΠΡΟΕΙΔΟΠΟΙΗΣΗ! ΚΙΝΔΥΝΟΣ ΠΥΡΚΑΓΙΑΣ!

- ▶ Πριν ψήσετε ένα συγκεκριμένο ψωμί με λειτουργία χρονοδιακόπτη, δοκιμάστε πρώτα τη συνταγή, για να διαπιστώσετε εάν η αναλογία των συστατικών μεταξύ τους ταιριάζει, ότι η ζύμη δεν είναι πολύ σφιχτή ή πολύ λεπτή ή ότι η ποσότητα δεν είναι πολύ μεγάλη, ώστε μετά να υπερχειλίσει ενδεχομένως.

- 1) Επιλέξτε ένα πρόγραμμα. Η οθόνη **A** σας δείχνει τον απαραίτητο χρόνο ψησίματος.

- 2) Με το πλήκτρο με βέλος **▲ D** μετατοπίστε το τέλος του προγράμματος. Κατά το πρώτο πάτημα ο τελικός χρόνος μετατοπίζεται έως το επόμενο δέκατο. Κάθε περαιτέρω πάτημα του πλήκτρου με βέλος **▲ D** μετατοπίζει τον τελικό χρόνο κατά 10 λεπτά. Με πατημένο το πλήκτρο με βέλος επιταχύνετε αυτή τη διαδικασία. Η οθόνη σας δείχνει τη συνολική διάρκεια χρόνου ψησίματος και χρόνου επιβράδυνσης. Σε περίπτωση υπέρβασης της πιθανής χρονικής μετατόπισης μπορείτε να διορθώσετε το χρόνο με το πλήκτρο με βέλος **▼ D**.

- 3) Επιβεβαιώστε τη ρύθμιση του χρονοδιακόπτη με το πλήκτρο Έναρξη/Διακοπή **B**. Η λυχνία ένδειξης λειτουργίας **E** αρχίζει να αναβοσβήνει. Το διπλό σημείο στην οθόνη **A** αναβοσβήνει και ο προγραμματισμένος χρόνος ξεκινά.

Μόλις το πρόγραμμα ξεκινήσει, ανάβει διαρκώς η λυχνία ένδειξης λειτουργίας **E**. Με την ολοκλήρωση της διαδικασίας ψησίματος ακούγονται δέκα ηχητικά σήματα και η οθόνη **A** προβάλλει το σύμβολο 0:00.

Παράδειγμα:

Είναι 8:00 και θέλετε σε 7 ώρες και 30 λεπτά, δηλαδή στις 15:30, να έχετε φρέσκο ψωμί. Επιλέξτε πρώτα το πρόγραμμα 1 και πιάστε μετά τα πλήκτρα με βέλη **D** τόσο, έτσι ώστε στην οθόνη **A** να εμφανιστεί η ώρα 7:30, εφόσον ο χρόνος μέχρι τον τερματισμό κρατά 7 ώρες και 30 λεπτά.

ΥΠΟΔΕΙΞΗ

- ▶ Στο πρόγραμμα "Μαρμελάδα" η λειτουργία χρονοδιακόπτη δεν διατίθεται.

ΥΠΟΔΕΙΞΗ

- ▶ Μη χρησιμοποιείτε τη λειτουργία χρονοδιακόπτη όταν επεξεργάζεστε ευπαθή τρόφιμα, όπως αβγά, γάλα, κρέμα ή τυρί.

Πριν από το ψήσιμο

Για μια επιτυχή διαδικασία ψησίματος λαμβάνετε υπόψη τους ακόλουθους παράγοντες:

Υλικά

⚠ ΠΡΟΕΙΔΟΠΟΙΗΣΗ! **ΚΙΝΔΥΝΟΣ ΠΥΡΚΑΓΙΑΣ!**

- ▶ Απομακρύνετε τη φόρμα ψησίματος **7** από το περίβλημα πριν γεμίσετε με τα υλικά. Εάν τα υλικά μπουν στον χώρο ψησίματος μπορεί με την θέρμανση των αντιστάσεων να προκληθεί πυρκαγιά.
- Βάζετε τα υλικά πάντα με τη δοθείσα σειρά στη φόρμα ψησίματος **7**.
- Όλα τα υλικά πρέπει να έχουν φτάσει σε θερμοκρασία δωματίου, ώστε να έχετε μια βέλτιστη ζύμωση της μαγιάς.

⚠ ΠΡΟΕΙΔΟΠΟΙΗΣΗ! **ΚΙΝΔΥΝΟΣ ΠΥΡΚΑΓΙΑΣ!**

- ▶ Σε καμία περίπτωση μην χρησιμοποιείτε μεγαλύτερες ποσότητες από αυτές που έχουν οριστεί. Υπερβολικό ζυμάρι μπορεί να βγει έξω από τη φόρμα ψησίματος **7** και να προκαλέσει στα ζεστά θερμοκρασιακά στοιχεία πυρκαγιά.
- Προσέχετε για ένα ακριβές μέτρημα των ποσοτήτων υλικών. Ακόμα και οι ελάχιστες αποκλίσεις από τη δοθείσα ποσότητα στη συνταγή μπορούν να επηρεάσουν το αποτέλεσμα ψησίματος.

Ψήσιμο ψωμιού

Προετοιμασία

ΥΠΟΔΕΙΞΗ

- ▶ Τοποθετείτε τον αρτοποιασκευαστή σε μια επίπεδη και σταθερή επιφάνεια.
- 1) Τραβήξτε τη φόρμα ψησίματος **7** έξω από τη συσκευή προς τα επάνω.
 - 2) Εισάγετε τα άγκιστρα ζυμώνματος **6** στους άξονες κίνησης στη φόρμα ψησίματος **7**. Προσέξτε ώστε να είναι σωστά στερεωμένα.

- 3) Βάλτε τα υλικά της συνταγής σας στη φόρμα ψησίματος **7**. Βάλτε πρώτα τα υγρά, τη ζάχαρη, το αλάτι και μετά το αλεύρι, και τη μαγιά σαν τελευταίο συστατικό.

ΥΠΟΔΕΙΞΗ

- ▶ Προσέξτε ώστε η μαγιά να μην έρθει σε επαφή με το αλάτι ή με υγρά.
- 4) Τοποθετήστε πάλι τη φόρμα ψησίματος **7**. Προσέξτε ώστε να έχει κουμπώσει σωστά.
 - 5) Κλείστε το καπάκι της συσκευής **2**.
 - 6) Εισάγετε το βύσμα στην πρίζα. Ακούγεται ένας ήχος σήματος και στη οθόνη **A** εμφανίζεται ο αριθμός προγράμματος και η χρονική διάρκεια για το Πρόγραμμα 1.
 - 7) Επιλέξτε το πρόγραμμά σας με το πλήκτρο επιλογής προγράμματος **C**. Κάθε εισαγωγή επιβεβαιώνεται με έναν ήχο σήματος.
 - 8) Επιλέξτε εάν χρειάζεται το μέγεθος του ψωμιού με το πλήκτρο **F**.
 - 9) Επιλέξτε το βαθμό ροδίσματος **C** του ψωμιού σας. Στην οθόνη **A** το βέλος σας δείχνει εάν έχετε ρυθμίσει ανοιχτόχρωμο, μέτριο ή σκουρόχρωμο. Εδώ μπορείτε επίσης να επιλέξετε τη ρύθμιση „Γρήγορο“, για να μειώσετε το χρόνο, στον οποίο φουσκώνει η ζύμη.

ΥΠΟΔΕΙΞΗ

- ▶ Στα προγράμματα 6, 7 και 11 δεν είναι δυνατή η λειτουργία „Βαθμός ροδίσματος“. Η λειτουργία „Γρήγορο“ είναι δυνατή μόνο για τα προγράμματα 1 - 4.
 - ▶ Στα προγράμματα 6, 7, 11 και 12 δεν είναι δυνατή η ρύθμιση του βάρους ψωμιού.
- 10) Τώρα έχετε τη δυνατότητα να ρυθμίσετε μέσω της λειτουργίας χρονοδιακόπτη την τελική χρονική στιγμή του προγράμματός σας. Μπορείτε να εισάγετε μια μέγιστη χρονική μετατόπιση έως και 15 ώρες.

ΥΠΟΔΕΙΞΗ

- ▶ Για το πρόγραμμα 11 αυτή η λειτουργία δεν είναι δυνατή.

Εκκίνηση προγράμματος

Τώρα εκκινήστε το πρόγραμμα με το πλήκτρο Έναρξη/Διακοπή **B**.

ΥΠΟΔΕΙΞΗ

- Τα προγράμματα 1, 2, 3, 4, 6 και 8 ξεκινούν με μια φάση προθέρμανσης 10 έως 30 λεπτών (εκτός της γρήγορης λειτουργίας, βλ. πίνακα διαδικασίας προγράμματος). Εδώ τα άγκιστρα ζυμώνματος **6** δεν κινούνται. Αυτό δεν είναι σφάλμα της συσκευής.

Το πρόγραμμα διεξάγει αυτόματα τις διαφορετικές λειτουργίες εργασίας.

Μπορείτε να παρακολουθείτε τη διαδικασία προγράμματος από το παράθυρο παρακολούθησης **1** του αρτοποιαστικού. Περιστασιακά μπορεί κατά τη διάρκεια του ψησίματος να έχουμε δημιουργία υγρασίας στο παράθυρο παρακολούθησης **1**. Το καπάκι της συσκευής **2** μπορεί κατά τη φάση ζυμώνματος να ανοίξει.

ΥΠΟΔΕΙΞΗ

- Μην ανοίγετε το καπάκι της συσκευής **2** κατά τη φάση φουσκώματος ή ψησίματος. Το ψωμί μπορεί να ξεφουσκώσει.

Τερματισμός προγράμματος

Με την ολοκλήρωση της διαδικασίας ψησίματος ακούγονται δέκα ηχητικά σήματα και η οθόνη **A** προβάλει το σύμβολο 0:00. Κατά τον τερματισμό του προγράμματος η συσκευή γυρίζει αυτόματα σε μία λειτουργία διατήρησης ζεστού για 60 λεπτά.

ΥΠΟΔΕΙΞΗ

- Αυτό δεν ισχύει για τα προγράμματα 6, 7 και 11.

Παράλληλα, κυκλοφορεί ζεστός αέρας στη συσκευή. Μπορείτε να τερματίσετε πρόωρα τη λειτουργία διατήρησης ζεστού, κρατώντας πατημένο το πλήκτρο Έναρξη/Διακοπή **B**, έως ότου ακουστεί ένας ήχος σήματος.

⚠ ΚΙΝΔΥΝΟΣ! ΗΛΕΚΤΡΟΠΛΗΞΙΑ!

- Τραβάτε το βύσμα από την πρίζα πριν ανοίξετε το καπάκι συσκευής **2**. Σε περίπτωση μη χρήσης πρέπει η συσκευή να αποσυνδέεται πάντα από το δίκτυο ρεύματος!

Αφαίρεση ψωμιού

Χρησιμοποιείτε κατά το βγάλσιμο της φόρμας ψησίματος **7** πάντα πανιά κουζίνας ή προστατευτικά γάντια. Κρατήστε τη φόρμα ψησίματος **7** λοξά πάνω από μια σχάρα και κουνήστε την ελαφρά, έως ότου το ψωμί ξεκολλήσει από αυτήν **7**.

Εάν το ψωμί δεν ξεκολλάει από το άγκιστρο ζυμώνματος **6**, απομακρύνετε προσεκτικά το άγκιστρο ζυμώνματος **6** με το εσώκλειστο εργαλείο απομάκρυνσης άγκιστρου **10**.

ΥΠΟΔΕΙΞΗ

Μη χρησιμοποιείτε μεταλλικά αντικείμενα, τα οποία μπορούν να γδάρουν την αντικολητική επιστρώση. Αμέσως μετά την απομάκρυνση του ψωμιού πλένετε τη φόρμα ψησίματος **7** με ζεστό νερό. Έτσι εμποδίζετε το να κολλήσει το άγκιστρο ζυμώνματος **6** στον άξονα κίνησης.

ΣΥΜΒΟΥΛΗ

Όταν απομακρύνετε το άγκιστρο ζυμώνματος **6** μετά την τελευταία διαδικασία ζυμώνματος της ζύμης, το ψωμί δεν διαλύεται κατά την απομάκρυνση προς τα έξω από τη φόρμα ψησίματος **7**.

- Πιέστε για λίγο το πλήκτρο Έναρξη/Διακοπή **B**, ώστε να διακόψετε το πρόγραμμα εντελώς στην αρχή της φάσης ψησίματος ή τραβήξτε το βύσμα από την πρίζα. Πρέπει να συνδέσετε πάλι το βύσμα εντός 10 λεπτών με το δίκτυο ρεύματος, ώστε η διαδικασία ψησίματος να μπορεί κατόπιν να συνεχιστεί.
- Ανοίξτε το καπάκι συσκευής **2** και βγάλτε έξω τη φόρμα ψησίματος **7**. Με αλεύρι στα χέρια μπορείτε να απομακρύνετε τη ζύμη και τα άγκιστρα ζυμώνματος **6**.
- Τοποθετήστε πάλι τη ζύμη στη φόρμα ψησίματος **7**. Τοποθετήστε τη φόρμα ψησίματος **7** πάλι μέσα και κλείστε το καπάκι της συσκευής **2**.
- Βάλτε εάν απαιτείται το βύσμα στην πρίζα. Το πρόγραμμα ψησίματος συνεχίζεται.

Αφήστε το ψωμί να κρυώσει για 15 - 30 λεπτά, πριν το καταναλώσετε.

Βεβαιωθείτε πριν από το κόψιμο του ψωμιού ότι δεν υπάρχει κανένα άγκιστρο ζυμώνματος **6** μέσα στη ζύμη.

Μηνύματα ασφαλιμάτων

- Όταν η οθόνη **A** δείχνει το σύμβολο „HHH“, αφότου έχει εκκινηθεί το πρόγραμμα, η θερμοκρασία του αρτοποιασκευαστή είναι ακόμα πολύ υψηλή. Σταματήστε το πρόγραμμα και τραβήξτε το βύσμα. Ανοίξτε το καπάκι της συσκευής **2** και αφήστε τη συσκευή να κρυώσει για 20 λεπτά, πριν συνεχίσετε τη χρήση της.
- Όταν δεν μπορεί να εκκινηθεί κανένα νέο πρόγραμμα, αφότου ο αρτοποιασκευαστής έχει ήδη ολοκληρώσει ένα πρόγραμμα, το μηχάνημα είναι ακόμα πολύ καυτό. Σε αυτή την περίπτωση η ένδειξη οθόνης γυρίζει στη βασική θέση (Πρόγραμμα 1). Ανοίξτε το καπάκι της συσκευής **2** και αφήστε τη συσκευή να κρυώσει για 20 λεπτά, πριν συνεχίσετε τη χρήση της.

ΥΠΟΔΕΙΞΗ

- ▶ Μη δοκιμάσετε να θέσετε σε λειτουργία τη συσκευή, προτού αυτή κρυώσει. Αυτό γίνεται μόνο στο πρόγραμμα 12.
- Όταν η οθόνη προβάλει τα σύμβολα „EE0“, „EE1“ ή „LLI“, αφότου έχει εκκινηθεί το πρόγραμμα, απενεργοποιήστε πρώτα τον αρτοποιασκευαστή και μετά ενεργοποιήστε τον πάλι, τραβώντας το βύσμα από την πρίζα και εισάγοντάς το πάλι. Εάν η ένδειξη σφάλματος συνεχίζει να προβάλλεται, απευθυνθείτε στο τμήμα εξυπηρέτησης πελατών.

Καθαρισμός και φροντίδα

⚠ ΚΙΝΔΥΝΟΣ! ΗΛΕΚΤΡΟΠΛΗΞΙΑ!

- ▶ Τραβάτε πριν από κάθε καθαρισμό το βύσμα από την πρίζα και αφήνετε τη συσκευή να κρυώνει εντελώς. Προστατεύετε τη συσκευή από την υγρασία, διότι κάτι τέτοιο ίσως έχει επακλόουθο μια ηλεκτροπληξία. Τηρείτε σχετικά και τις υποδείξεις ασφαλείας.

ΠΡΟΣΟΧΗ! ΥΛΙΚΕΣ ΖΗΜΙΕΣ!

- ▶ Τα εξαρτήματα της συσκευής ή τα αξεσουάρ δεν μπορούν να πλυθούν στο πλυντήριο πιάτων!
- ▶ Μη χρησιμοποιείτε κατά τον καθαρισμό του αρτοποιασκευαστή χημικά απορρυπαντικά ή διαλυτικά.

Περιβλημα, καπάκι, χώρος ψησίματος

- Απομακρύνετε όλα τα υπολείμματα από τον χώρο ψησίματος με ένα υγρό πανί ή με ένα ελαφρά βρεγμένο σφουγγάρι.
- Σκουπίζετε το περιβλημα και το καπάκι επίσης μόνο με ένα νωπό πανί ή σφουγγάρι. Για ελαφρύ καθαρισμό μπορεί το καπάκι της συσκευής **2** να απομακρυνθεί από το περιβλημα:
 - Ανοίξτε το καπάκι της συσκευής **2**, έως ότου οι σφηνοειδείς πλαστικές προεξοχές ταιριάζουν μέσα από τα ανοίγματα των οδηγών μεντεσέδων.
 - Τραβήξτε έξω το καπάκι της συσκευής **2** από τους οδηγούς μεντεσέδων.
 - Για να μοντάρετε το καπάκι της συσκευής **2**, οδηγήστε τις πλαστικές προεξοχές μέσα από το άνοιγμα των οδηγών μεντεσέδων.

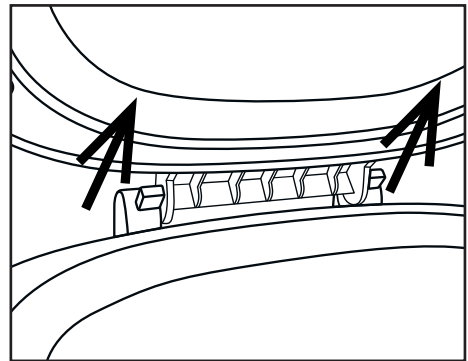

- Για να τοποθετήσετε πάλι το καπάκι της συσκευής **2** μετά τον καθαρισμό, οδηγήστε το πλαστικό έκκεντρο μέσα από το άνοιγμα των οδηγών μεντεσέδων.
- Στεγνώστε τα όλα καλά και βεβαιωθείτε ότι πριν από μια νέα χρήση όλα τα εξαρτήματα είναι απολύτως στεγνά.

Φόρμα ψησίματος, άγκιστρα ζυμώματος και αξεσουάρ

ΠΡΟΣΟΧΗ! ΥΛΙΚΕΣ ΖΗΜΙΕΣ!

- ▶ Ποτέ μην βυθίζετε τη φόρμα ψησίματος **7** σε νερό ή άλλα υγρά.
- ▶ Οι επιφάνειες της φόρμας ψησίματος **7** και το άγκιστρο ζυμώματος **6** προβλέπονται με μια αντικολλητική επίστρωση. Μη χρησιμοποιείτε κατά τον καθαρισμό επιθετικά απορρυπαντικά, μέσα τριβής ή αντικείμενα τα οποία μπορούν να οδηγήσουν σε γδαρσίματα στις επιφάνειες.

ΥΠΟΔΕΙΞΗ

- ▶ Μέσω της υγρασίας και του ατμού μπορεί να αλλάξει η εξωτερική εμφάνιση των επιφανειών με την πάροδο του χρόνου. Αυτό δεν επηρεάζει τη λειτουργικότητα, ούτε μειώνει την ποιότητα.
- Πριν από τον καθαρισμό απομακρύνετε τη φόρμα ψησίματος **7** και τα άγκιστρα ζυμώματος **6** από το χώρο ψησίματος.
- Απομακρύνετε τα άγκιστρα ζυμώματος **6** από τη φόρμα ψησίματος **7**. Εάν τα άγκιστρα ζυμώματος **6** δεν βγαίνουν από τη φόρμα ψησίματος **7**, γεμίστε τη φόρμα ψησίματος **7** περίπου για 30 λεπτά με καυτό νερό. Τα άγκιστρα ζυμώματος **6** μπορούν τώρα να αφαιρεθούν. Καθαρίστε τα άγκιστρα ζυμώματος **6** σε ζεστό νερό και προσθέστε ένα ήπιο απορρυπαντικό. Σε περίπτωση που έχουν δημιουργηθεί έντονες κρούστες, αφήστε τα άγκιστρα ζυμώματος **6** να μαλακώσουν μέσα σε νερό πλήσης, έως ότου οι κρούστες να μπορούν να διαλυθούν με τη βοήθεια μιας βούρτσας καθαρισμού. Εάν ο συγκρατητήρας στο άγκιστρο ζυμώματος **6** έχει βουλώσει, μπορείτε να τον καθαρίσετε προσεκτικά με μια ξύλινη ράβδο.

Στεγνώστε καλά τα άγκιστρα ζυμώματος **6** μετά τον καθαρισμό.

- Σκουπίστε την εξωτερική πλευρά της φόρμας ψησίματος **7** με ένα υγρό πανί.
- Καθαρίστε το εσωτερικό της φόρμας ψησίματος **7** με ζεστό νερό και λίγο απορρυπαντικό. Στην περίπτωση δημιουργίας κρούστας στη φόρμα ψησίματος **7**, γεμίστε την **7** με νερό και προσθέστε ήπιο απορρυπαντικό. Περιμένετε, έως ότου οι κρούστες μαλακώσουν και διαλύονται με μια βούρτσα καθαρισμού. Στη συνέχεια ξεπλύνετε τη φόρμα ψησίματος **7** με άφθονο καθαρό νερό και στεγνώστε την καλά
- Καθαρίστε το δοχείο μέτρησης **8**, το κουτάλι μέτρησης **9** και το εργαλείο απομάκρυνσης άγκιστρων ζυμώματος **10** σε ζεστό νερό και προσθέστε ήπιο απορρυπαντικό. Κατόπιν ξεπλύνετε τα εξαρτήματα με καθαρό νερό, ώστε να απομακρύνετε υπολείμματα απορρυπαντικού. Στεγνώστε τα όλα καλά.

Απόρριψη



Σε καμία περίπτωση μην απορρίψετε τη συσκευή στα οικιακά απορρίμματα. Αυτό το προϊόν υπόκειται στην Ευρωπαϊκή Οδηγία 2012/19/EU.

Απορρίψτε τη συσκευή μέσω μιας εγκεκριμένης επιχείρησης απόρριψης ή μέσω της κοινοτικής επιχείρησης απόρριψης.

Τηρείτε τις ισχύουσες προδιαγραφές. Σε περίπτωση αμφιβολιών επικοινωνείτε με την αρμόδια επιχείρηση απόρριψης.



Απομακρύνετε όλα τα υλικά συσκευασιών με φιλικό προς το περιβάλλον τρόπο.

Εγγύηση και σέρβις

Η παρούσα συσκευή διαθέτει 3 χρόνια εγγύηση από την ημερομηνία αγοράς. Η συσκευή κατασκευάστηκε και ελέγχθηκε προσεκτικά πριν από την αποστολή. Παρακαλούμε φυλάξτε την απόδειξη ταμείου ως απόδειξη για την αγορά. Σε περίπτωση απαίτησης εγγύησης επικοινωνήστε τηλεφωνικώς με το τμήμα σέρβις. Μόνο έτσι μπορεί να εξασφαλιστεί δωρεάν αποστολή του εμπορεύματός σας.

Η απαίτηση εγγύησης ισχύει μόνο για σφάλματα υλικού ή κατασκευής, ωστόσο όχι για ζημιές από τη μεταφορά, για φθειρόμενα εξαρτήματα, όπως φόρμες ψησίματος ή άγκιστρα ζυμώνματος, ή για ζημιές σε εύθραυστα εξαρτήματα, π.χ. διακόπτες ή συσσωρευτές. Το προϊόν προορίζεται μόνο για ιδιωτική και όχι για επαγγελματική χρήση.

Σε περίπτωση κακής μεταχείρισης και ακατάλληλης χρήσης, χρήσης βίας και παρεμβάσεων, οι οποίες δεν διεξήχθησαν από το εξουσιοδοτημένο μας τμήμα σέρβις, η εγγύηση παύει να ισχύει. Τα νομικά σας δικαιώματα δεν περιορίζονται μέσω αυτής της εγγύησης.

Ο χρόνος εγγύησης δεν επιμηκύνεται μέσω της εγγύησης. Αυτό ισχύει και για εξαρτήματα, τα οποία έχουν αντικατασταθεί και επισκευαστεί. Ενδεχόμενες ήδη υπάρχουσες ζημιές και ελλείψεις κατά την αγορά πρέπει να γνωστοποιηθούν αμέσως μετά το άνοιγμα της συσκευασίας, το αργότερο ωστόσο δύο ημέρες μετά την ημερομηνία αγοράς. Μετά τη λήξη του χρόνου εγγύησης, τυχόν εμφανιζόμενες επισκευές χρεώνονται.

GR Σέρβις Ελλάδα

Tel.: 801 5000 019 (0,03 EUR/Min.)

E-Mail: kompnass@lidl.gr

IAN 270356

CY Σέρβις Κύπρος

Tel.: 8009 4409

E-Mail: kompnass@lidl.com.cy

IAN 270356

Τηλεφωνικό κέντρο (Hotline):

Δευτέρα έως Παρασκευή, 8:00 – 20:00 (CET)

Εισαγωγέας

KOMPERNASS HANDELS GMBH









BURGSTRASSE 21

44867 BOCHUM









GERMANY

www.kompnass.com



Διαδικασία προγράμματος

Πρόγραμμα	1. Κανονικό						2. Απλό					
	Ανοιχτόχρωμο Μέτριο Σκουρόχρωμο			Γρήγορο			Ανοιχτόχρωμο Μέτριο Σκουρόχρωμο			Γρήγορο		
Βάρος	750 g	1000 g	1250 g	750 g	1000 g	1250 g	750 g	1000 g	1250 g	750 g	1000 g	1250 g
Χρόνος (ώρες)	2:58	3:05	3:15	2:14	2:20	2:25	3:13	3:18	3:25	2:18	2:25	2:30
Προθέρμανση (λεπτά) 	15	15	20	Δ/Δ	Δ/Δ	Δ/Δ	10	10	15	Δ/Δ	Δ/Δ	Δ/Δ
Ζύωμα 1 (λεπτά) 	12	13	13	12	13	13	12	12	15	12	13	13
Φούσκωμα 1 (λεπτά) 	25	25	25	10	10	10	20	20	20	10	10	10
Ζύωμα 2 (λεπτά) 	2 3A* 5	2 5A 5	2 5A 5	2 1A 5	2 2A 5	2 2A 5	2 3A* 8	2 5A 8	2 5A 8	2 1A 5	2 2A 5	2 2A 5
Φούσκωμα 2 (λεπτά) 	30	30	30	18	18	18	43	41	35	18	18	18
Φούσκωμα 3 (λεπτά) 	30	30	30	30	30	30	35	35	35	30	30	30
Ψήσιμο (λεπτά) 	56	60	65	56	60	65	60	65	70	60	65	70
Διατήρηση ζεστού (λεπτά) 	60	60	60	60	60	60	60	60	60	60	60	60
Προσθήκη υλικών (ώρες που απομένουν)	2:01	2:05	2:10	1:49	1:53	1:58	2:26	2:29	2:28	1:53	1:58	2:03
Προρύθμιση του χρόνου	15ώ	15ώ	15ώ	15ώ	15ώ	15ώ	15ώ	15ώ	15ώ	15ώ	15ώ	15ώ









* 3A σημαίνει ότι μετά τα 3 λεπτά ζυμώματος ακούγονται 10 σήματα ήχου και ταυτόχρονα εμφανίζεται η ένδειξη οθόνης „ADD“ ⑥. Αυτό υπενθυμίζει ότι τώρα μπορείτε να προσθέσετε υλικά όπως φρούτα ή καρύδια.

Πρόγραμμα	3. Ολικής άλεσης						4. Γλυκό					
	Ανοιχτόχρωμο Μέτριο Σκουρόχρωμο			Γρήγορο			Ανοιχτόχρωμο Μέτριο Σκουρόχρωμο			Γρήγορο		
Βάρος	750 g	1000 g	1250 g	750 g	1000 g	1250 g	750 g	1000 g	1250 g	750 g	1000 g	1250 g
Χρόνος (ώρες)	3:18	3:25	3:35	2:24	2:30	2:35	2:56	3:01	3:10	2:10	2:16	2:20
Προθέρμανση (λεπτά) 	15	15	20	Δ/Δ	Δ/Δ	Δ/Δ	10	10	15	Δ/Δ	Δ/Δ	Δ/Δ
Ζύωμα 1 (λεπτά) 	11	12	12	11	13	13	12	12	12	11	12	12
Φούσκωμα 1 (λεπτά) 	30	30	30	10	10	10	25	25	25	10	10	10
Ζύωμα 2 (λεπτά) 	2 3A 8	2 5A 8	2 5A 8	2 2A 5	2 2A 5	2 2A 5	2 4A* 6	2 5A 6	2 5A 6	2 1A 6	2 2A 6	2 2A 6
Φούσκωμα 2 (λεπτά) 	38	38	38	23	23	23	35	35	35	18	18	18
Φούσκωμα 3 (λεπτά) 	35	35	35	35	35	35	30	30	30	30	30	30
Ψήσιμο (λεπτά) 	56	60	65	56	60	65	52	56	60	52	56	60
Διατήρηση ζεστού (λεπτά) 	60	60	60	60	60	60	60	60	60	60	60	60
Προσθήκη υλικών (ώρες που απομένουν)	2:17	2:21	2:26	1:59	2:03	2:08	2:03	2:07	2:11	1:46	1:50	1:54
Προρύθμιση του χρόνου	15ώ	15ώ	15ώ	15ώ	15ώ	15ώ	15ώ	15ώ	15ώ	15ώ	15ώ	15ώ

* 4A σημαίνει ότι μετά τα 4 λεπτά ζυμώματος ακούγονται 10 σήματα ήχου και ταυτόχρονα εμφανίζεται η ένδειξη οθόνης „ADD“ ⑥. Αυτό υπενθυμίζει ότι τώρα μπορείτε να προσθέσετε υλικά όπως φρούτα ή καρύδια.

Πρόγραμμα	5. Εξπρές			6. Ζύμη	7. Ζύμη για ζυμαρικά	8. Ψωμί με βουτυρόγαλα			9. Χωρίς γλουτένη		
Βαθμός ροδίσματος	Ανοιχτόχρωμο Μέτριο Σκουρόχρωμο			Δ/Δ	Δ/Δ	Ανοιχτόχρωμο Μέτριο Σκουρόχρωμο			Ανοιχτόχρωμο Μέτριο Σκουρόχρωμο		
Βάρος	750 g	1000 g	1250 g	Δ/Δ	Δ/Δ	750 g	1000 g	1250 g	750 g	1000 g	1250 g
Χρόνος (ώρες)	1:15	1:18	1:20	1:50	0:15	3:17	3:21	3:30	2:14	2:20	2:25
Προθέρμανση (λεπτά) 	Δ/Δ	Δ/Δ	Δ/Δ	10	Δ/Δ	25	25	30	Δ/Δ	Δ/Δ	Δ/Δ
Ζύμωμα 1 (λεπτά) 	8	8	8	12	15	10	10	10	12	13	13
Φούσκωμα 1 (λεπτά) 	Δ/Δ	Δ/Δ	Δ/Δ	10	Δ/Δ	20	20	20	10	10	10
Ζύμωμα 2 (λεπτά) 	Δ/Δ 2A 5	Δ/Δ 2A 5	Δ/Δ 2A 5	Δ/Δ 3A 5	Δ/Δ Δ/Δ Δ/Δ	2 5A* 8	2 5A* 8	2 5A* 8	2 1A 5	2 2A 5	2 2A 5
Φούσκωμα 2 (λεπτά) 	Δ/Δ	Δ/Δ	Δ/Δ	25	Δ/Δ	45	45	45	18	18	18
Φούσκωμα 3 (λεπτά) 	20	20	20	45	Δ/Δ	30	30	30	30	30	30
Ψήσιμο (λεπτά) 	40	43	45	Δ/Δ	Δ/Δ	52	56	60	56	60	65
Διατήρηση ζεστού (λεπτά) 	60	60	60	Δ/Δ	Δ/Δ	60	60	60	60	60	60
Προσθήκη υλικών (ώρες που απομένουν)	1:05	1:08	1:10	1:15	Δ/Δ	2:15	2:19	2:23	1:49	1:53	1:58
Προρύθμιση του χρόνου	15ώ	15ώ	15ώ	15ώ	15ώ	15ώ	15ώ	15ώ	15ώ	15ώ	15ώ

* 5A σημαίνει ότι μετά τα 5 λεπτά ζυμώματος ακούγονται 10 σήματα ήχου και ταυτόχρονα εμφανίζεται η ένδειξη οθόνης „ADD” (6). Αυτό υπενθυμίζει ότι τώρα μπορείτε να προσθέσετε υλικά όπως φρούτα ή καρδιά.

Πρόγραμμα	10. Γλυκό			11. Μαρμελάδα	12. Ψήσιμο
Βαθμός ροδίσματος	Ανοιχτόχρωμο Μέτριο Σκουρόχρωμο			Δ/Δ	Ανοιχτόχρωμο Μέτριο Σκουρόχρωμο
Βάρος	750 g	1000 g	1250 g	Δ/Δ	Δ/Δ
Χρόνος (ώρες)	1:30	1:35	1:40	1:20	1:00
Προθέρμανση (λεπτά) 	Δ/Δ	Δ/Δ	Δ/Δ	Δ/Δ	Δ/Δ
Ζύμωμα 1 (λεπτά) 	15	15	15	Δ/Δ	Δ/Δ
Φούσκωμα 1 (λεπτά) 	Δ/Δ	Δ/Δ	Δ/Δ	15 Θερμότητα + ζύμωμα	Δ/Δ
Ζύμωμα 2 (λεπτά) 	Δ/Δ Δ/Δ Δ/Δ	Δ/Δ Δ/Δ Δ/Δ	Δ/Δ Δ/Δ Δ/Δ	Δ/Δ Δ/Δ Δ/Δ	Δ/Δ Δ/Δ Δ/Δ
Φούσκωμα 2 (λεπτά) 	Δ/Δ	Δ/Δ	Δ/Δ	Δ/Δ	Δ/Δ
Φούσκωμα 3 (λεπτά) 	Δ/Δ	Δ/Δ	Δ/Δ	45 Θερμότητα + ζύμωμα	Δ/Δ
Ψήσιμο (λεπτά) 	60 15 Φού- σκωμα	65 15 Φού- σκωμα	70 15 Φού- σκωμα	20 Φούσκωμα	60
Διατήρηση ζεστού (λεπτά) 	60	60	60	Δ/Δ	60
Προσθήκη υλικών (ώρες που απομένουν)	Δ/Δ	Δ/Δ	Δ/Δ	Δ/Δ	Δ/Δ
Προρύθμιση του χρόνου	15ώ	15ώ	15ώ	Δ/Δ	15ώ

Διόρθωση σφαλμάτων αρτοπαρασκευαστή

Τι κάνω όταν το άγκιστρο ζυμώματος 6 παραμένει μετά το ψήσιμο μέσα στη φόρμα ψησίματος 7 ;	Γεμίστε με καυτό νερό τη φόρμα ψησίματος 7 και περιστρέψτε το άγκιστρο ζυμώματος 6 , ώστε να διαλύσετε την κρούστα που βρίσκεται εκεί.
Τι συμβαίνει όταν το έτοιμο ψωμί παραμένει μέσα στον αρτοπαρασκευαστή;	Μέσω της "Λειτουργίας διατήρησης ζεστού" εξασφαλίζεται ότι το ψωμί διατηρείται ζεστό για περίπου 1 ώρα και προστατεύεται από την υγρασία. Εάν το ψωμί μείνει για περισσότερο από 1 ώρα μέσα στον αρτοπαρασκευαστή, μπορεί να αποκτήσει υγρασία.
Η φόρμα ψησίματος 7 και τα άγκιστρα ζυμώματος 6 ενδείκνυνται για πλυντήριο πιάτων;	Όχι. Πλύνετε τη φόρμα ψησίματος 7 και τα άγκιστρα ζυμώματος 6 με το χέρι.
Γιατί δεν αναμειγνύεται η ζύμη, παρότι το μοτέρ δουλεύει;	Ελέγξτε εάν τα άγκιστρα ζυμώματος 6 και η φόρμα ψησίματος 7 έχουν κουμπώσει καλά.
Τι πρέπει να κάνω όταν το άγκιστρο ζυμώματος 6 παραμένει μέσα στο ψωμί;	Απομακρύνετε το άγκιστρο ζυμώματος 6 με το εργαλείο απομάκρυνσης άγκιστρου ζυμώματος 10 .
Τι συμβαίνει σε περίπτωση διακοπής ρεύματος κατά τη διάρκεια ενός προγράμματος;	Σε περίπτωση διακοπής ρεύματος έως και 10 λεπτών, ο αρτοπαρασκευαστής ολοκληρώνει το πρόγραμμα που είχε διεξαχθεί τελευταίο.
Πόσο διαρκεί το ψήσιμο ψωμιού;	Αναζητήστε τους ακριβείς χρόνους από τον πίνακα "Διαδικασία προγράμματος".
Ποια βάρη ψωμιών μπορώ να ψήσω;	Μπορείτε να ψήσετε ψωμιά από 750 g - 1000 g - 1250 g.
Γιατί δεν χρησιμοποιείται η λειτουργία χρονοδιακόπτη κατά το ψήσιμο με φρέσκο γάλα;	Τα φρέσκα προϊόντα, όπως το γάλα ή τα αβγά, χαλάνε όταν μένουν για μεγάλο χρονικό διάστημα μέσα στη συσκευή.
Τι έχει συμβεί όταν ο αρτοπαρασκευαστής δε λειτουργεί, αφού του έχει πατηθεί το πλήκτρο Έναρξη/ Διακοπή B ;	Ορισμένες διαδικασίες εργασίας, όπως για παράδειγμα το „Ζέσταμα“ ή η „Ηρεμία“, αναγνωρίζονται δύσκολα. Ελέγξτε, βάσει του πίνακα „Διαδικασία προγράμματος“, ποιο τμήμα προγράμματος είναι το τρέχον. Ελέγξτε εάν η συσκευή λειτουργεί, κοιτάζοντας εάν η λυχνία ένδειξης λειτουργίας B ανάβει. Ελέγξτε εάν έχετε πατήσει σωστά το πλήκτρο Έναρξη/ Διακοπή B . Ελέγξτε εάν το βύσμα έχει συνδεθεί στο δίκτυο ρεύματος.
Η συσκευή κομματίζει τις σταφίδες.	Για να αποφύγετε το κομμάτισμα συστατικών, όπως φρούτα ή καρύδια, βάλτε τα στη ζύμη μετά το άκουσμα του ήχου.



Κάρτα παραγγελίας SBB 850 C1

► www.kompernass.com

Ποσότητα

(μέγ. 3 σετ ανά παραγγελία)

Περιγραφή προϊόντος

Τιμή μονάδας

Συνολικό ποσό

- 1 Φόρμα ψησίματος συμπεριλ 2 άγκιστρα ζυμώματος



10 €

+ _____ €

+ 5 €

συν έξοδα διαχείρισης για ταχυδρομικά τέλη, διαχείριση, συσκευασία και αποστολή.

- 4 άγκιστρα ζυμώματος



10 €

+ _____ €

+ 3 €

συν έξοδα διαχείρισης για ταχυδρομικά τέλη, διαχείριση, συσκευασία και αποστολή.

- Υπόδειξη: Εάν η παραγγελία σας αποτελείται από πολλά είδη (σετ 4 τεμαχίων άγκιστρο ζυμώματος και φόρμα ψησίματος) πληρώνετε πάντα την ανώτερη τιμή εξόδων αποστολής 5 ευρώ!

= _____ €

Όροι πληρωμής

Κατάθεση σε τραπεζικό λογαριασμό

(Τόπος, ημερομηνία)

(Υπογραφή)

Κάρτα παραγγελίας SBB 850 C1

► www.kompernas.com

- 1) Σημειώστε με κεφαλαία κάτω από το "Αποστολέας/πελάτης" το όνομά σας, την προσφώνησή σας, και το αριθμό του τηλεφώνου σας. (για ενδεδειγμένες ερωτήσεις).
- 2) Κατάθεση σε τραπεζικό λογαριασμό: Καταθέστε το συνολικό ποσό εκ των προτέρων στον ακόλουθο τραπεζικό λογαριασμό:

Kompernaß Handelsgesellschaft mbH
IBAN: DE03440100460799566462
SWIFT (BIC): PBNKDEFF 440
Τράπεζα: Postbank Dortmund AG

Στην κατάθεσή σας, να αναφέρετε ως σκοπό χρήση, το προϊόν όπως επίσης το όνομα και τη διεύθυνσή σας. Στέλνετε την πλήρως συμπληρωμένη κάρτα παραγγελίας, μέσα σ' ένα φάκελο στην ακόλουθη ταχυδρομική μας διεύθυνση.

Kompernaß Handelsgesellschaft mbH
Burgstrasse 21
44867 Bochum
Germany

Αποστολέας / Παραγγέλων
(Παρακαλούμε συμπληρώστε πλήρως και με
ΚΕΦΑΛΑΙΑ)

Επώνυμο, όνομα

Οδός

Ταχυδρομικός κώδικας, τόπος

Χηῆά

Τηλέφωνο

ΣΗΜΑΝΤΙΚΟ

- Παρακαλούμε επικοινωνήστε επαρκή γραμματισόσημα στην ταχυδρομική αποστολή.
- Γράψτε το όνομα σας ως αποστολέα στο φάκελο.

Inhaltsverzeichnis

Einleitung	90
Bestimmungsgemäßer Gebrauch	90
Lieferumfang	90
Gerätebeschreibung	90
Technische Daten	90
Sicherheitshinweise	91
Vor dem ersten Gebrauch	95
Eigenschaften	95
Bedienfeld	95
Programme	97
Timer-Funktion	98
Vor dem Backen	98
Brot backen	99
Reinigung und Pflege	101
Entsorgung	102
Garantie und Service	102
Importeur	103
Programmablauf	104
Fehlerbehebung Brotbackautomat	108

BROTBACKAUTOMAT

Einleitung

Herzlichen Glückwunsch zum Kauf Ihres neuen Gerätes.

Sie haben sich damit für ein hochwertiges Produkt entschieden. Die Bedienungsanleitung ist Bestandteil dieses Produkts. Sie enthält wichtige Hinweise für Sicherheit, Gebrauch und Entsorgung. Machen Sie sich vor der Benutzung des Produkts mit allen Bedien- und Sicherheitshinweisen vertraut. Benutzen Sie das Produkt nur wie beschrieben und für die angegebenen Einsatzbereiche. Händigen Sie alle Unterlagen bei Weitergabe des Produkts an Dritte mit aus.

Bestimmungsgemäßer Gebrauch

Benutzen Sie Ihren Brotbackautomaten nur zum Brotbacken und zur Herstellung von Marmeladen/Konfitüren im häuslichen Bereich.

Verwenden Sie das Gerät nicht zum Trocknen von Lebensmitteln oder Gegenständen. Verwenden Sie den Brotbackautomat nicht im Freien.

Verwenden Sie nur vom Hersteller empfohlenes Zubehör. Nicht empfohlenes Zubehör kann das Gerät beschädigen.

Dieses Gerät ist ausschließlich für die Benutzung in privaten Haushalten bestimmt.

Benutzen Sie das Gerät nicht gewerblich!

Lieferumfang

Brotbackautomat

Backform

2 Knethaken

Messbecher

Messlöffel

Knethakenentferner

Bedienungsanleitung

Kurzinformation

Rezeptheft

HINWEIS

- Kontrollieren Sie das Gerät nach dem Auspacken auf Vollständigkeit und auf Transportschäden. Wenden Sie sich gegebenenfalls an den Service (siehe Kapitel "Garantie und Service").

Gerätebeschreibung

Abbildung A:

- 1 Sichtfenster
- 2 Gerätedeckel
- 3 Belüftungsschlitze
- 4 Netzkabel
- 5 Bedienfeld

Abbildung B:

- 6 2 Knethaken
- 7 Backform bis zu 1250 g Brotgewicht
- 8 Messbecher
- 9 Messlöffel
- 10 Knethakenentferner

Technische Daten

Nennspannung: 220 - 240 V ~ / 50 Hz

Leistungsaufnahme: 850 Watt

Sicherheitshinweise

- ▶ Lesen Sie bitte die Bedienungsanleitung erst vollständig durch, bevor Sie das Gerät benutzen!

⚠ GEFAHR - ELEKTRISCHER SCHLAG!

- ▶ Überprüfen Sie vor jedem Gebrauch Netzkabel und -stecker. Wenn das Netzkabel dieses Gerätes beschädigt wird, muss es durch den Hersteller, seinen Kundendienst oder eine ähnlich qualifizierte Person ersetzt werden, um Gefährdungen zu vermeiden.
- ▶ Verlegen Sie das Netzkabel nicht über scharfe Kanten oder in der Nähe von heißen Flächen oder Gegenständen. Die Isolierung des Kabels kann beschädigt werden.
- ▶ Ziehen Sie den Netzstecker bei Nichtgebrauch und vor jeder Reinigung des Gerätes aus der Steckdose.
- ▶ Tauchen Sie den Brotbackautomaten nicht in Wasser oder andere Flüssigkeiten. Es besteht Stromschlaggefahr!
- ▶ Reinigen Sie das Gerät nicht mit kratzenden Putzschwämmen. Wenn sich Partikel des Schwammes lösen und mit elektrischen Teilen in Berührung kommen, besteht Stromschlaggefahr.

⚠ WARNUNG! VERLETZUNGSGEFAHR!

- ▶ Erstickungsgefahr! Kinder ersticken bei unsachgemäßem Gebrauch des Verpackungsmaterials. Entsorgen Sie dieses sofort nach dem Auspacken oder bewahren Sie es für Kinder unzugänglich auf.
- ▶ Um Stolper- oder Unfallgefahren zu vermeiden, ist das Gerät mit einem kurzen Netzkabel ausgestattet.
- ▶ Lassen Sie das Gerät abkühlen und ziehen Sie den Netzstecker, bevor Sie Teile des Zubehörs herausnehmen oder einsetzen.
- ▶ Verlegen Sie ein Verlängerungskabel so, dass niemand darüber stolpern und unbeabsichtigt daran ziehen kann.

⚠️ WARNUNG! VERLETZUNGSGEFAHR!

- ▶ Wenn Kinder in der Nähe sind, bitte das Gerät gut beaufsichtigen! Wenn das Gerät nicht benutzt wird, wie auch vor dem Reinigen, bitte den Netzstecker ziehen. Vor dem Abnehmen einzelner Teile das Gerät auskühlen lassen.
- ▶ Dieses Gerät kann von Kindern ab 8 Jahren sowie von Personen mit reduzierten physischen, sensorischen oder mentalen Fähigkeiten oder Mangel an Erfahrung und/oder Wissen benutzt werden, wenn sie beaufsichtigt oder bezüglich des sicheren Gebrauchs des Gerätes unterwiesen wurden und die daraus resultierenden Gefahren verstanden haben.
- ▶ Kinder dürfen nicht mit dem Gerät spielen.
- ▶ Reinigung und Benutzer-Wartung dürfen nicht durch Kinder durchgeführt werden, es sei denn, sie sind älter als 8 Jahre und beaufsichtigt.
- ▶ Kinder jünger als 8 Jahre sind vom Gerät und der Anschlussleitung fernzuhalten.
- ▶ Dieses Gerät entspricht den einschlägigen Sicherheitsbestimmungen. Überprüfung, Reparatur und technische Wartung dürfen nur von einem qualifizierten Fachhändler durchgeführt werden. Ansonsten erlischt der Garantieanspruch.
- ▶ Vorsicht! Der Brotbackautomat wird heiß. Fassen Sie das Gerät erst an, wenn es sich abgekühlt hat oder benutzen Sie zum Anfassen einen Topflappen.
- ▶ Versetzen Sie den Brotbackautomaten nicht, wenn sich heißer oder flüssiger Inhalt, z. B. Konfitüre, in der Backform befindet. Es besteht Verbrennungsgefahr!
- ▶ Kommen Sie nie während der Benutzung mit den rotierenden Knethaken in Berührung. Es besteht Verletzungsgefahr!
- ▶ Während des Betriebs kann die Temperatur der berührbaren Oberfläche sehr hoch sein. Verbrennungsgefahr!



Achtung! Heiße Oberfläche!

Teile des Gerätes werden während des Betriebes sehr heiß!

Verbrennungsgefahr!

⚠️ WARNUNG! BRANDGEFAHR!

- ▶ Benutzen Sie keine externe Zeitschaltuhr oder ein separates Fernwirk-system um das Gerät zu betreiben.
- ▶ Stellen Sie das Gerät nicht in der Nähe von brennbaren Materialien, explosiven und/oder brennbaren Gasen auf. Zu anderen Gegenständen muss ein Mindestabstand von 10 cm eingehalten werden.
- ▶ Decken Sie das Gerät niemals mit einem Handtuch oder anderen Materialien ab. Hitze und Dampf müssen entweichen können. Ein Brand kann entstehen, wenn das Gerät mit brennbarem Material abgedeckt wird oder in Kontakt kommt, wie z. B. mit Vorhängen.
- ▶ Stellen Sie keine Gegenstände auf das Gerät und bedecken Sie es nicht.
- ▶ Legen Sie nie Alufolie oder andere metallische Gegenstände in den Brotbackautomaten. Dies kann zu einem Kurzschluss führen.
- ▶ Überschreiten Sie beim Backen niemals die Menge von 700 g Mehl und geben Sie niemals mehr als 1 ¼ Päckchen Trockenhefe dazu. Der Teig kann überlaufen und einen Brand verursachen!
Ausgenommen hiervon sind glutenfreie Brote. Hierbei dürfen bis maximal 2 Päckchen Trockenhefe hinzugegeben werden (siehe Rezeptheft).

ACHTUNG – SACHSCHADEN!

- ▶ Achten Sie darauf, dass die Lüftungsschlitze des Gerätes nicht verdeckt werden. Überhitzungsgefahr!
- ▶ Lassen Sie das Gerät während des Betriebes nie unbeaufsichtigt!
- ▶ Das Gerät nur innerhalb von Gebäuden benutzen.
- ▶ Das Gerät nie auf oder neben einen Gas- oder Elektroherd, einen heißen Backofen oder sonstigen Hitzequellen stellen. Überhitzungsgefahr!
- ▶ Die Verwendung von nicht vom Hersteller empfohlenem Zubehör kann zu Beschädigungen führen. Das Gerät nur für den vorgesehenen Zweck verwenden. Ansonsten erlischt der Garantieanspruch.
- ▶ Starten Sie ein Backprogramm nur mit eingesetzter Backform. Ansonsten kann es zu irreparablen Schäden am Gerät führen.
- ▶ Ziehen Sie den Stecker nicht am Netzkabel aus der Steckdose.

ACHTUNG – SACHSCHADEN!

- ▶ Benutzen Sie den Brotbackautomaten nicht, um darin Speisen oder Utensilien aufzubewahren.
- ▶ Benutzen Sie das Gerät nie mit leerer oder ohne Backform. Das führt zu irreparablen Schäden am Gerät.
- ▶ Schließen Sie immer den Deckel während des Betriebs.
- ▶ Entfernen Sie nie die Backform während des Betriebs.
- ▶ Stellen Sie das Gerät ausschließlich auf eine trockene, ebene und hitzeunempfindliche Oberfläche.
- ▶ Überprüfen Sie vor dem Anschluss, ob Stromart und Netzspannung mit den Angaben auf dem Typenschild übereinstimmen.
- ▶ Wenn Sie ein Verlängerungskabel verwenden, muss die maximal zulässige Leistung des Kabels der Leistung des Brotbackautomaten entsprechen.

Vor dem ersten Gebrauch

Auspacken

- Packen Sie das Gerät aus und entfernen Sie jegliches Verpackungsmaterial, sowie eventuelle Aufkleber und Schutzfolien.
- Kontrollieren Sie das Gerät nach dem Auspacken auf Vollständigkeit und auf Transportschäden. Wenden Sie sich gegebenenfalls an den Service (siehe Kapitel "Garantie und Service").

Erste Reinigung

Wischen Sie Backform **7**, Knethaken **6** und Außenfläche des Brotbackautomaten vor der Inbetriebnahme mit einem sauberen, feuchten Tuch ab. Verwenden Sie keine kratzenden Putzschwämme oder Scheuermittel. Entfernen Sie, falls noch nicht geschehen, die Schutzfolie auf dem Bedienfeld **5**.

Erstes Aufheizen

- 1) Setzen Sie ausschließlich beim **erstmaligen Aufheizen** die leere Backform **7** in das Gerät ein und schließen Sie den Gerätedeckel **2**.

⚠️ WARNUNG! BRANDGEFAHR!

- ▶ Lassen Sie den Brotbackautomaten nicht länger als 5 Minuten mit leerer Backform **7** aufheizen. Es besteht die Gefahr der Überhitzung.
- 2) Wählen Sie das Programm 12, wie im Kapitel „Programme“ beschrieben und drücken Sie Start/Stop **B**, um das Gerät für 5 Minuten aufzuheizen.
 - 3) Drücken und halten Sie nach 5 Minuten die Taste Start/Stop **B**, bis ein langer Signalton ertönt, um das Programm zu beenden.

HINWEIS

Da die Heizelemente leicht eingefettet sind, kann es bei der ersten Inbetriebnahme zu leichter Geruchsbildung kommen. Diese ist unschädlich und hört nach kurzer Zeit auf. Sorgen Sie für ausreichende Belüftung, öffnen Sie zum Beispiel ein Fenster.

- 4) Lassen Sie das Gerät vollständig abkühlen und wischen Sie noch einmal Backform **7**, Knethaken **6** und Außenfläche des Brotbackautomaten mit einem sauberen, feuchten Tuch ab.

Eigenschaften

Mit dem Brotbackautomat haben Sie die Möglichkeit Brot nach Ihrem Geschmack zu backen.

- Sie können zwischen 12 verschiedenen Programmen wählen.
- Sie können fertige Backmischungen verarbeiten.
- Sie können Nudel- oder Brötchenteig kneten lassen oder Marmelade herstellen.
- Durch das Programm „Glutenfrei“ können Sie glutenfreie Backmischungen und Rezepte mit glutenfreien Mehlen, wie z. B. Maismehl, Buchweizenmehl und Kartoffelmehl, backen.



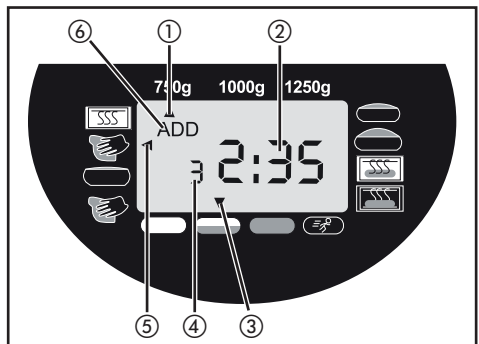
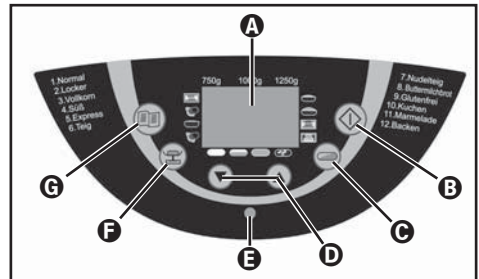

DE
AT
CH

Bedienfeld



A Display

Anzeige für

- ① die Auswahl des Gewichts (750 g, 1000 g, 1250 g)
- ② die noch verbleibende Betriebszeit in Stunden und die programmierte Zeitvorwahl
- ③ den gewählten Bräunungsgrad (Hell , Mittel , Dunkel , Schnell )
- ④ die gewählte Programm-Nummer
- ⑤ den Programmablauf
- ⑥ das Zugeben von Zutaten („ADD“)

B Start / Stop

Zum Starten und Beenden des Betriebes oder um eine Timer-Programmierung zu löschen.

Um den Betrieb anzuhalten, drücken Sie kurz die Start/Stop-Taste **B**, bis ein Signalton ertönt und die Zeit im Display **A** blinkt. Durch erneutes Drücken der Start/Stop-Taste **B** kann der Betrieb innerhalb von 10 Minuten wieder fortgesetzt werden. Wenn Sie vergessen, das Programm fortzusetzen, wird das Programm nach 10 Minuten automatisch fortgesetzt.

Um den Betrieb vollständig zu beenden oder die Einstellungen zu löschen, drücken Sie für 3 Sekunden die Start/Stop-Taste **B** bis ein langer Signalton ertönt.

HINWEIS

- ▶ Drücken Sie nicht die Start/Stop-Taste **B**, wenn Sie lediglich den Zustand des Brotes kontrollieren wollen. Beobachten Sie den Backvorgang durch das Sichtfenster **1**.

ACHTUNG!

- ▶ Beim Drücken aller Tasten muss ein Signalton ertönen, ausgenommen, während das Gerät in Betrieb ist.

C Bräunungsgrad (oder Schnellmodus)

Wahl des Bräunungsgrades oder wechseln in den Schnellmodus (Hell/Mittel/Dunkel/Schnell). Drücken Sie wiederholt die Taste Bräunungsgrad **C**, bis der Pfeil über dem gewünschten Bräunungsgrad erscheint. Für die Programme 1 - 4 können Sie durch mehrmaliges Drücken der Taste Bräunungsgrad **C** den Schnellmodus aktivieren, um den Backvorgang zu verkürzen. Drücken Sie die Taste Bräunungsgrad **C** so oft, bis der Pfeil über „Schnell“ erscheint. Bei den Programmen 6, 7 und 11 kann kein Bräunungsgrad gewählt werden.

D Timer

Zeiterverzögertes Backen.

HINWEIS

E Betriebsindikationslampe

Die Betriebsindikationslampe **E** zeigt mit ihrem Leuchten an, dass gerade ein Programm läuft. Wenn Sie ein Programm mit der Timer-Funktion zeitverzögert starten wollen, blinkt die Betriebsindikationslampe **E**, sobald Sie die Einstellung des Timers bestätigt haben. Sobald das Programm startet, leuchtet die Betriebsindikationslampe **E** dauerhaft.

F Brotgewicht

Wahl des Brotgewichtes (750 g/1000 g/1250 g). Drücken Sie diese Taste wiederholt, bis der Pfeil unter dem gewünschten Gewicht erscheint. Die Gewichtsangaben (750 g/1000 g/1250 g) beziehen sich auf die Menge der eingefüllten Zutaten in die Backform **7**.

HINWEIS

- ▶ Die Voreinstellung beim Einschalten des Gerätes ist 1250 g. Bei den Programmen 6, 7, 11 und 12 können Sie das Brotgewicht nicht einstellen.

ⓐ Programmwahl (Menü)

Aufrufen des gewünschten Backprogramms (1-12). Im Display **A** erscheint die Programm-Nummer und die entsprechende Backzeit.

Memory-Funktion

Das Programm wird beim Wiedereinschalten nach einem Stromausfall von bis zu ca. 10 Minuten an gleicher Stelle fortgesetzt. Dies gilt jedoch nicht bei Löschen/Beenden des Backvorgangs oder bei Betätigung der Start/Stop-Taste **B** bis ein langer Signalton ertönt.

Sichtfenster **1**

Durch das Sichtfenster **1** können Sie den Backvorgang beobachten.

Programme

Mit der Taste Programmwahl **G** wählen Sie das gewünschte Programm aus. Die entsprechende Programm-Nummer wird im Display **A** angezeigt. Die Backzeiten sind abhängig von den gewählten Programmkombinationen. Siehe Kapitel „Programmablauf“.

Programm 1: Normal

Für Weiß- und Mischbrote die hauptsächlich aus Weizen- oder Roggenmehl bestehen. Das Brot hat eine kompakte Konsistenz. Die Bräunung des Brotes stellen Sie mit der Taste Bräunungsgrad **C** ein.

Programm 2: Locker

Für leichte Brote aus gut gemahlenem Mehl. Das Brot ist in der Regel locker und hat eine knusprige Kruste.

Programm 3: Vollkorn

Für Brote mit kräftigeren Mehlsorten, z. B. Weizenvollkornmehl und Roggenmehl. Das Brot wird kompakter und schwerer.

Programm 4: Süß

Für Brote mit Zutaten aus Fruchtsäften, Kokosnussflocken, Rosinen, Trockenfrüchten, Schokolade oder zusätzlichem Zucker. Durch eine längere Aufgehphase wird das Brot leichter und luftiger.

Programm 5: Express

Für das Kneten, Teig gehen lassen und das Backen wird weniger Zeit benötigt. Für dieses Programm sind jedoch nur Rezepte geeignet, die keine schweren Zutaten oder kräftige Mehlsorten enthalten. Beachten Sie, dass das Brot bei diesem Programm weniger luftig und nicht ganz so schmackhaft werden kann.

Programm 6: Teig (kneten)

Zur Herstellung von Hefeteig für Brötchen, Pizza oder Zöpfe. Der Backvorgang entfällt bei diesem Programm.

Programm 7: Nudelteig

Für die Zubereitung von Nudelteig. Der Backvorgang entfällt bei diesem Programm.

Programm 8: Buttermilchbrot

Für Brote die aus Buttermilch oder Joghurt hergestellt werden.

Programm 9: Glutenfrei

Für Brote aus glutenfreien Mehlen und Backmischungen. Glutenfreie Mehle benötigen länger für die Aufnahme von Flüssigkeiten und haben andere Triebeigenschaften.

Programm 10: Kuchen

Die Zutaten werden bei diesem Programm geknetet, gehen gelassen und gebacken. Benutzen Sie Backpulver für dieses Programm.

Programm 11: Marmelade

Zum Herstellen von Marmeladen, Konfitüren, Gelees und Fruchtaufstrichen.

Programm 12: Backen

Zum Nachbacken von Broten, die zu hell oder nicht ganz durch gebacken sind oder Fertigteige. Alle Knet- oder Ruhevorgänge entfallen bei diesem Programm. Das Brot wird bis zu einer Stunde nach Ende des Backvorgangs warm gehalten. Dadurch wird verhindert, dass das Brot zu feucht wird. Das Programm 12 backt das Brot für 60 Minuten.

Um diese Funktionen vorzeitig zu beenden, drücken und halten Sie die Start/Stop-Taste **B**, bis ein langer Signalton ertönt. Um das Gerät auszuschalten, trennen Sie das Gerät vom Stromnetz.

HINWEIS

- ▶ Bei den Programmen 1, 2, 3, 4, 5, 6, 8 und 9 ertönt während des Programmablaufs ein Signalton und „ADD“ (6) erscheint im Display. Fügen Sie unmittelbar danach weitere Zutaten, wie Früchte oder Nüsse hinzu. Sie müssen dazu das Programm nicht unterbrechen. Die Zutaten werden durch den Knethaken (6) nicht zerkleinert. Wenn Sie den Timer eingestellt haben, können Sie sämtliche Zutaten auch zu Programmbeginn in die Backform (7) geben. Früchte und Nüsse sollten Sie in diesem Fall vor der Zugabe etwas zerkleinern.

Timer-Funktion

Die Timer-Funktion ermöglicht Ihnen ein zeitverzögertes Backen.

Mit den Pfeiltasten ▼ und ▲ (D) stellen Sie den gewünschten Endzeitpunkt des Backvorgangs ein. Die maximale Zeitverzögerung beträgt 15 Stunden.

⚠️ WARNUNG! BRANDGEFAHR!

- ▶ Bevor Sie ein bestimmtes Brot mit der Timerfunktion backen wollen, probieren Sie das Rezept erst aus, um sicherzustellen, dass das Verhältnis der Zutaten zueinander stimmt, der Teig nicht zu fest oder zu dünn ist oder die Menge zu groß ist und dann evtl. überläuft.

- 1) Wählen Sie ein Programm. Das Display (A) zeigt Ihnen die benötigte Backdauer.
- 2) Mit der Pfeiltaste ▲ (D) verschieben Sie das Ende des Programmes. Beim erstmaligen Betätigen verschiebt sich die Endzeit bis zum nächsten Zehner. Jedes weitere Drücken der Pfeiltaste ▲ (D) verschiebt die Endzeit um 10 Minuten. Bei gedrückter Pfeiltaste beschleunigen Sie diesen Vorgang. Das Display zeigt Ihnen die Gesamtdauer von Backzeit und Verzögerungszeit. Bei einer Überschreitung der möglichen Zeitverschiebung können Sie mit der Pfeiltaste ▼ (D) die Zeit korrigieren.
- 3) Bestätigen Sie die Einstellung des Timers mit der Start/Stop-Taste (B).

Die Betriebsindikationslampe (E) beginnt zu blinken. Der Doppelpunkt im Display (A) blinkt und die programmierte Zeit beginnt abzulaufen.

Sobald das Programm startet, leuchtet die Betriebsindikationslampe (E) dauerhaft. Bei Beendigung des Backvorgangs ertönen zehn Signaltöne und das Display (A) zeigt 0:00 an.

Beispiel:

Es ist 8.00 Uhr und Sie möchten in 7 Stunden und 30 Minuten, also um 15:30 Uhr, frisches Brot haben. Wählen Sie zunächst das Programm 1 und drücken Sie dann die Pfeiltasten (D) so lange, bis im Display (A) 7:30 erscheint, da die Zeit bis zur Fertigstellung 7 Stunden und 30 Minuten beträgt.

HINWEIS

- ▶ Bei dem Programm „Marmelade“ steht die Timer-Funktion nicht zur Verfügung.

HINWEIS

- ▶ Verwenden Sie die Timer-Funktion nicht, wenn Sie schnell verderbliche Lebensmittel wie Eier, Milch, Sahne oder Käse verarbeiten.

Vor dem Backen

Für einen erfolgreichen Backvorgang berücksichtigen Sie bitte folgende Faktoren:

Zutaten

⚠️ WARNUNG! BRANDGEFAHR!

- ▶ Nehmen Sie die Backform (7) aus dem Gehäuse, bevor Sie die Zutaten einfüllen. Wenn Zutaten in den Backraum gelangen, kann durch die Erhitzung der Heizschlangen ein Brand entstehen.
- Geben Sie die Zutaten immer in der angegebenen Reihenfolge in die Backform (7).
- Alle Zutaten sollten auf Zimmertemperatur erwärmt sein, um einen optimalen Gärvorgang der Hefe zu erhalten.

⚠️ WARNUNG! BRANDGEFAHR!

► Verwenden Sie auf keinen Fall größere Mengen als angegeben. Zu viel Teig kann über die Backform **7** laufen und an den heißen Heizschlangen einen Brand verursachen.

■ Achten Sie auf ein genaues Abmessen der Zutatenmengen. Bereits geringe Abweichungen von der im Rezept angegebenen Menge können das Backergebnis beeinflussen.

Brot backen**Vorbereitung****HINWEIS**

► Stellen Sie den Brotbackautomaten auf einen geraden und festen Untergrund.

- 1) Ziehen Sie die Backform **7** aus dem Gerät nach oben heraus.
- 2) Stecken Sie die Knethaken **6** auf die Antriebswellen in der Backform **7**. Achten Sie darauf, dass sie fest sitzen.
- 3) Geben Sie die Zutaten Ihres Rezeptes in die Backform **7**. Geben Sie zuerst die Flüssigkeiten, Zucker, Salz und dann Mehl hinzu, die Hefe als letzte Zutat.

HINWEIS

► Achten Sie darauf, dass Hefe nicht mit Salz oder Flüssigkeiten in Berührung kommt.

- 4) Setzen Sie die Backform **7** wieder ein. Achten Sie darauf, dass sie richtig einrastet.
- 5) Schließen Sie den Gerätedeckel **2**.
- 6) Stecken Sie den Netzstecker in die Steckdose. Es ertönt ein Signalton und im Display **A** erscheint die Programm-Nummer und Zeitdauer für das Programm 1.
- 7) Wählen Sie Ihr Programm mit der Programmwahl-Taste **G**. Jede Eingabe wird mit einem Signalton bestätigt.
- 8) Wählen Sie gegebenenfalls die Größe des Brotes mit der Taste **F**.

- 9) Wählen Sie den Bräunungsgrad **C** Ihres Brotes. Im Display **A** zeigt Ihnen der Pfeil, ob Sie Hell, Mittel oder Dunkel eingestellt haben. Sie können hier auch die Einstellung „Schnell“ wählen, um die Zeit, in der der Teig geht, abzukürzen.

HINWEIS

► Für die Programme 6, 7 und 11 ist die Funktion „Bräunungsgrad“ nicht möglich. Die Funktion „Schnell“ ist nur für die Programme 1 - 4 möglich. Für die Programme 6, 7, 11 und 12 ist die Einstellung des Brotgewichts nicht möglich.

- 10) Sie haben jetzt die Möglichkeit über die Timer-Funktion den Endzeitpunkt Ihres Programms einzustellen. Sie können eine maximale Zeitverschiebung von bis zu 15 Stunden eingeben.

HINWEIS

► Für das Programm 11 ist diese Funktion nicht möglich.

Programm starten

Starten Sie nun das Programm mit der Start/Stop Taste **B**.

HINWEIS

► Die Programme 1, 2, 3, 4, 6 und 8 starten mit einer 10- bis 30-minütigen Vorheizphase (außer Schnell-Modus, siehe Tabelle Programmablauf). Die Knethaken **6** bewegen sich hierbei nicht. Das ist kein Fehler des Gerätes.

Das Programm führt automatisch die verschiedenen Arbeitsgänge durch.

Sie können den Programmablauf über das Sichtfenster **1** Ihres Brotbackautomaten beobachten. Gelegentlich kann es während des Backvorgangs zur Feuchtigkeitsbildung im Sichtfenster **1** kommen. Der Gerätedeckel **2** kann während der Knetphase geöffnet werden.

HINWEIS

► Öffnen Sie den Gerätedeckel **2** nicht während der Geh- oder Backphase. Das Brot kann in sich zusammenfallen.

Programm beenden

Bei Beendigung des Backvorgangs ertönen zehn Signaltöne und das Display **A** zeigt 0:00 an. Bei Beendigung des Programms schaltet das Gerät automatisch auf einen bis zu 60 Minuten andauernden Warmhaltebetrieb.

HINWEIS

- Das gilt nicht für die Programme 6, 7 und 11.

Dabei zirkuliert warme Luft im Gerät. Die Warmhaltefunktion können Sie vorzeitig beenden, indem Sie die Start/Stop-Taste **B** bis zum Ertönen der Signaltöne gedrückt halten.

⚠ GEFAHR! ELEKTRISCHER SCHLAG!

- Ziehen Sie den Netzstecker aus der Steckdose, bevor Sie den Gerätedeckel **2** öffnen. Bei Nichtbenutzung sollte das Gerät immer vom Stromnetz getrennt werden!

Brot entnehmen

Verwenden Sie beim Herausnehmen der Backform **7** immer Topflappen oder Schutzhandschuhe. Halten Sie die Backform **7** schräg über einen Rost und schütteln leicht, bis sich das Brot aus der Backform **7** löst.

Löst sich das Brot nicht von den Knethaken **6**, entfernen Sie vorsichtig die Knethaken **6** mit dem beiliegenden Knethakenentferner **10**.

HINWEIS

Benutzen Sie keine Metallgegenstände, die zu Kratzern auf der Antihafbeschichtung führen können. Spülen Sie gleich nach der Brotentnahme die Backform **7** mit warmem Wasser aus. Sie verhindern ein Festsetzen der Knethaken **6** an der Antriebswelle.

TIPP

Wenn Sie die Knethaken **6** nach dem letzten Knetvorgang entnehmen, wird das Brot beim Herausnehmen aus der Backform **7** nicht aufgerissen.

- Drücken Sie kurz die Start/Stop-Taste **B**, um das Programm ganz zu Anfang der Backphase zu unterbrechen oder ziehen Sie den Stecker aus der Netzsteckdose. Sie müssen den Netzstecker innerhalb von 10 Minuten wieder mit dem Stromnetz verbinden, damit der Backvorgang anschließend fortgesetzt werden kann.
- Öffnen Sie den Gerätedeckel **2** und nehmen Sie die Backform **7** heraus. Mit bemehlten Händen können Sie den Teig entnehmen und die Knethaken **6** entfernen.
- Legen Sie den Teig wieder in die Backform **7**. Setzen Sie die Backform **7** wieder ein und schließen Sie den Gerätedeckel **2**.
- Stecken Sie ggf. den Netzstecker in die Steckdose. Das Backprogramm wird fortgesetzt.

Lassen Sie das Brot 15 - 30 Minuten abkühlen, bevor Sie es verzehren.

Vergewissern Sie sich vor dem Anschneiden des Brotes immer, dass sich kein Knethaken **6** im Teig befindet.

Fehlermeldungen

- Wenn das Display **A** „HHH“ anzeigt, nachdem das Programm gestartet wurde, ist die Temperatur des Brotbackautomaten noch zu hoch. Stoppen Sie das Programm und ziehen Sie den Netzstecker. Öffnen Sie den Gerätedeckel **2** und lassen Sie das Gerät 20 Minuten abkühlen, bevor Sie es weiter benutzen.
- Wenn sich kein neues Programm starten lässt, nachdem der Brotbackautomat ein Programm bereits abgeschlossen hat, ist er noch zu heiß. In diesem Fall springt die Displayanzeige auf die Grundeinstellung (Programm 1). Öffnen Sie den Gerätedeckel **2** und lassen Sie das Gerät 20 Minuten abkühlen, bevor Sie es weiter benutzen.

HINWEIS

- Versuchen Sie nicht, das Gerät in Betrieb zu nehmen, bevor es sich abgekühlt hat. Das funktioniert nur bei dem Programm 12.

- Wenn das Display „EEO“, „EE1“ oder „LLL“ anzeigt, nachdem das Programm gestartet wurde, schalten Sie den Brotbackautomaten zunächst aus und danach wieder ein, indem Sie den Netzstecker aus der Steckdose ziehen und ihn dann wieder einstecken. Sollte die Fehleranzeige weiterhin bestehen, wenden Sie sich an den Kundendienst.

Reinigung und Pflege

⚠ GEFAHR! ELEKTRISCHER SCHLAG!

- ▶ Ziehen Sie vor jeder Reinigung den Netzstecker aus der Steckdose und lassen Sie das Gerät ganz abkühlen. Schützen Sie das Gerät vor Feuchtigkeit, da dies einen Stromschlag zur Folge haben kann. Beachten Sie dazu bitte auch die Sicherheitshinweise.

ACHTUNG! SACHSCHADEN!

- ▶ Die Geräte- bzw. Zubehörteile sind nicht spülmaschinengeeignet!
- ▶ Benutzen Sie zum Reinigen des Brotbackautomaten keine chemischen Reinigungsmittel oder Verdüner.

Gehäuse, Deckel, Backraum

- Entfernen Sie alle Rückstände im Backraum mit einem feuchten Tuch oder einem leicht angefeuchteten weichen Schwamm.
- Wischen Sie das Gehäuse und den Deckel ebenfalls nur mit einem feuchten Tuch oder Schwamm ab.
Zur leichten Reinigung kann der Gerätedeckel **2** vom Gehäuse entfernt werden:
 - Öffnen Sie den Gerätedeckel **2**, bis die keilförmigen Kunststoffnasen durch die Öffnungen der Scharnierführungen passen.
 - Ziehen Sie den Gerätedeckel **2** aus den Scharnierführungen heraus.
 - Um den Gerätedeckel **2** zu montieren, führen Sie die Kunststoffnasen durch die Öffnung der Scharnierführungen.

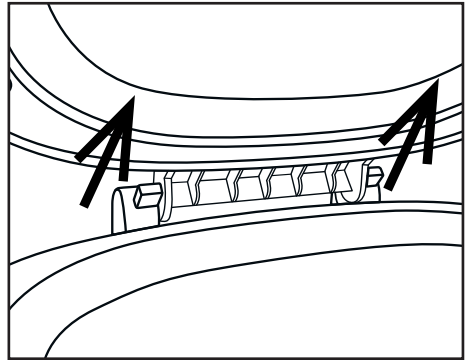

- Trocknen Sie alles gut ab und stellen Sie sicher, dass vor einer erneuten Benutzung alle Teile trocken sind.

Backform, Knethaken und Zubehör

ACHTUNG! SACHSCHADEN!

- ▶ Tauchen Sie die Backform **7** niemals in Wasser oder andere Flüssigkeiten.
- ▶ Die Oberflächen der Backform **7** und der Knethaken **6** sind mit einer Antihafbeschichtung versehen. Benutzen Sie bei der Reinigung keine aggressiven Reinigungsmittel, Scheuermittel oder Gegenstände, die zu Kratzern auf den Oberflächen führen können.

HINWEIS

- ▶ Durch Feuchtigkeit und Dampf kann sich das Aussehen der Oberflächen im Laufe der Zeit verändern. Dies ist keine Beeinträchtigung der Funktionsfähigkeit oder Qualitätsminderung.
- Nehmen Sie vor der Reinigung die Backform **7** und die Knethaken **6** aus dem Backraum.

- Nehmen Sie die Knethaken **6** aus der Backform **7**. Sollten sich die Knethaken **6** nicht aus der Backform **7** lösen, füllen Sie die Backform **7** für etwa 30 Minuten mit heißem Wasser. Die Knethaken **6** sollten sich nun lösen lassen. Reinigen Sie die Knethaken **6** in warmem Wasser und geben Sie ein mildes Spülmittel hinzu. Bei hartnäckigen Verkrustungen, lassen Sie die Knethaken **6** solange in dem Spülwasser einweichen, bis sich die Verkrustungen mit Hilfe einer Spülbürste lösen lassen. Ist die Einsatzhalterung im Knethaken **6** verstopft, können Sie diese vorsichtig mit einem Holzstäbchen reinigen. Trocknen Sie die Knethaken **6** nach der Reinigung gründlich ab.
- Wischen Sie die Außenseite der Backform **7** mit einem feuchten Tuch ab.
- Reinigen Sie den Innenraum der Backform **7** mit warmem Wasser und etwas Spülmittel. Bei Verkrustungen in der Backform **7**, füllen Sie Wasser in die Backform **7** und geben Sie ein mildes Spülmittel hinzu. Lassen Sie es solange stehen, bis die Verkrustungen eingeweicht sind und sich mit einer Spülbürste lösen lassen. Spülen Sie die Backform **7** danach mit viel klarem Wasser aus und trocknen Sie diese gut ab.
- Reinigen Sie den Messbecher **8**, den Messlöffel **9** und den Knethakenentferner **10** in warmem Wasser und geben Sie ein mildes Spülmittel hinzu. Spülen Sie die Teile danach mit klarem Wasser ab, um Spülmittelreste zu beseitigen. Trocknen Sie alles gründlich ab.

Entsorgung



Werfen Sie das Gerät keinesfalls in den normalen Hausmüll. Dieses Produkt unterliegt der europäischen Richtlinie 2012/19/EU.

Entsorgen Sie das Gerät über einen zugelassenen Entsorgungsbetrieb oder über Ihre kommunale Entsorgungseinrichtung.

Beachten Sie die aktuell geltenden Vorschriften. Setzen Sie sich im Zweifelsfall mit Ihrer Entsorgungseinrichtung in Verbindung.



Führen Sie alle Verpackungsmaterialien einer umweltgerechten Entsorgung zu.

Garantie und Service

Sie erhalten auf dieses Gerät 3 Jahre Garantie ab Kaufdatum. Das Gerät wurde sorgfältig produziert und vor Anlieferung gewissenhaft geprüft.

Bitte bewahren Sie den Kassenbon als Nachweis für den Kauf auf. Bitte setzen Sie sich im Garantiefall mit Ihrer Servicestelle telefonisch in Verbindung. Nur so kann eine kostenlose Einsendung Ihrer Ware gewährleistet werden.

Die Garantieleistung gilt nur für Material- oder Fabrikationsfehler, nicht aber für Transportschäden, Verschleißteile, wie Backformen oder Knethaken, oder für Beschädigungen an zerbrechlichen Teilen, z. B. Schalter oder Akkus. Das Produkt ist lediglich für den privaten und nicht für den gewerblichen Gebrauch bestimmt.

Bei missbräuchlicher und unsachgemäßer Behandlung, Gewaltanwendung und bei Eingriffen, die nicht von unserer autorisierten Service-Niederlassung vorgenommen wurden, erlischt die Garantie. Ihre gesetzlichen Rechte werden durch diese Garantie nicht eingeschränkt.

Die Garantiezeit wird durch die Gewährleistung nicht verlängert. Dies gilt auch für ersetzte und reparierte Teile. Eventuell schon beim Kauf vorhandene Schäden und Mängel müssen sofort nach dem Auspacken gemeldet werden, spätestens aber zwei Tage nach Kaufdatum. Nach Ablauf der Garantiezeit anfallende Reparaturen sind kostenpflichtig.

DE Service Deutschland

Tel.: 0800 5435 111 (Kostenfrei aus dem
dt. Festnetz/Mobilfunknetz)

E-Mail: kompernass@lidl.de

IAN 270356

AT Service Österreich

Tel.: 0820 201 222 (0,15 EUR/Min.)

E-Mail: kompernass@lidl.at

IAN 270356

CH Service Schweiz

Tel.: 0842 665566 (0,08 CHF/Min.,
Mobilfunk max. 0,40 CHF/Min.)

E-Mail: kompernass@lidl.ch

IAN 270356

DE
AT
CH

Erreichbarkeit Hotline:

Montag bis Freitag von 8:00 Uhr – 20:00 Uhr
(MEZ)

Importeur

KOMPERNASS HANDELS GMBH









BURGSTRASSE 21

44867 BOCHUM









GERMANY

www.kompernass.com

Programmablauf









Programm	1. Normal						2. Locker					
	Hell Mittel Dunkel			Schnell			Hell Mittel Dunkel			Schnell		
Größe	750 g	1000 g	1250 g	750 g	1000 g	1250 g	750 g	1000 g	1250 g	750 g	1000 g	1250 g
Zeit (Stunden)	2:58	3:05	3:15	2:14	2:20	2:25	3:13	3:18	3:25	2:18	2:25	2:30
Vorheizen (Min) 	15	15	20	N/A	N/A	N/A	10	10	15	N/A	N/A	N/A
Kneten 1 (Min) 	12	13	13	12	13	13	12	12	15	12	13	13
Gehen 1 (Min) 	25	25	25	10	10	10	20	20	20	10	10	10
Kneten 2 (Min) 	2 3A* 5	2 5A 5	2 5A 5	2 1A 5	2 2A 5	2 2A 5	2 3A* 8	2 5A 8	2 5A 8	2 1A 5	2 2A 5	2 2A 5
Gehen 2 (Min) 	30	30	30	18	18	18	43	41	35	18	18	18
Gehen 3 (Min) 	30	30	30	30	30	30	35	35	35	30	30	30
Backen (Min) 	56	60	65	56	60	65	60	65	70	60	65	70
Warmhalten (Min) 	60	60	60	60	60	60	60	60	60	60	60	60
Zutaten hinzugeben (Stunden verbleibend)	2:01	2:05	2:10	1:49	1:53	1:58	2:26	2:29	2:28	1:53	1:58	2:03
Voreinstellung der Zeit	15h	15h	15h	15h	15h	15h	15h	15h	15h	15h	15h	15h

* 3A heißt, dass nach den 3 Minuten kneten 10 Signaltöne erklingen und gleichzeitig die Displayanzeige „ADD“  erscheint. Dies erinnert Sie daran, dass Sie nun Zutaten wie Früchte oder Nüsse hinzugeben können.









Programm	3. Vollkorn						4. Süß					
	Hell Mittel Dunkel			Schnell			Hell Mittel Dunkel			Schnell		
Größe	750 g	1000 g	1250 g	750 g	1000 g	1250 g	750 g	1000 g	1250 g	750 g	1000 g	1250 g
Zeit (Stunden)	3:18	3:25	3:35	2:24	2:30	2:35	2:56	3:01	3:10	2:10	2:16	2:20
Vorheizen (Min) 	15	15	20	N/A	N/A	N/A	10	10	15	N/A	N/A	N/A
Kneten 1 (Min) 	11	12	12	11	13	13	12	12	12	11	12	12
Gehen 1 (Min) 	30	30	30	10	10	10	25	25	25	10	10	10
Kneten 2 (Min) 	2 3A 8	2 5A 8	2 5A 8	2 2A 5	2 2A 5	2 2A 5	2 4A* 6	2 5A 6	2 5A 6	2 1A 6	2 2A 6	2 2A 6
Gehen 2 (Min) 	38	38	38	23	23	23	35	35	35	18	18	18
Gehen 3 (Min) 	35	35	35	35	35	35	30	30	30	30	30	30
Backen (Min) 	56	60	65	56	60	65	52	56	60	52	56	60
Warmhalten (Min) 	60	60	60	60	60	60	60	60	60	60	60	60
Zutaten hinzugeben (Stunden verbleibend)	2:17	2:21	2:26	1:59	2:03	2:08	2:03	2:07	2:11	1:46	1:50	1:54
Voreinstellung der Zeit	15h	15h	15h	15h	15h	15h	15h	15h	15h	15h	15h	15h

 DE
AT
CH

* 4A heißt, dass nach den 4 Minuten kneten 10 Signaltöne erklingen und gleichzeitig die Displayanzeige „ADD“  erscheint. Dies erinnert Sie daran, dass Sie nun Zutaten wie Früchte oder Nüsse hinzugeben können.

Programm	5. Express			6. Teig	7. Nudel-teig	8. Buttermilch-brot			9. Glutenfrei		
Bräunungsgrad	Hell Mittel Dunkel			N/A	N/A	Hell Mittel Dunkel			Hell Mittel Dunkel		
Größe	750 g	1000 g	1250 g	N/A	N/A	750 g	1000 g	1250 g	750 g	1000 g	1250 g
Zeit (Stunden)	1:15	1:18	1:20	1:50	0:15	3:17	3:21	3:30	2:14	2:20	2:25
Vorheizen (Min) 	N/A	N/A	N/A	10	N/A	25	25	30	N/A	N/A	N/A
Kneten 1 (Min) 	8	8	8	12	15	10	10	10	12	13	13
Gehen 1 (Min) 	N/A	N/A	N/A	10	N/A	20	20	20	10	10	10
Kneten 2 (Min) 	N/A 2A 5	N/A 2A 5	N/A 2A 5	N/A 3A 5	N/A N/A N/A	2 5A* 8	2 5A* 8	2 5A* 8	2 1A 5	2 2A 5	2 2A 5
Gehen 2 (Min) 	N/A	N/A	N/A	25	N/A	45	45	45	18	18	18
Gehen 3 (Min) 	20	20	20	45	N/A	30	30	30	30	30	30
Backen (Min) 	40	43	45	N/A	N/A	52	56	60	56	60	65
Warmhalten (Min) 	60	60	60	N/A	N/A	60	60	60	60	60	60
Zutaten hinzugeben (Stunden verbleibend)	1:05	1:08	1:10	1:15	N/A	2:15	2:19	2:23	1:49	1:53	1:58
Voreinstellung der Zeit	15h	15h	15h	15h	15h	15h	15h	15h	15h	15h	15h

* 5A heißt, dass nach den 5 Minuten kneten 10 Signaltöne erklingen und gleichzeitig die Displayanzeige „ADD“  erscheint. Dies erinnert Sie daran, dass Sie nun Zutaten wie Früchte oder Nüsse hinzugeben können.

Programm	10. Kuchen			11. Marmelade	12. Backen
Bräunungsgrad	Hell Mittel Dunkel			N/A	Hell Mittel Dunkel
Größe	750 g	1000 g	1250 g	N/A	N/A
Zeit (Stunden)	1:30	1:35	1:40	1:20	1:00
Vorheizen (Min) 	N/A	N/A	N/A	N/A	N/A
Kneten 1 (Min) 	15	15	15	N/A	N/A
Gehen 1 (Min) 	N/A	N/A	N/A	15 Hitze + kneten	N/A
Kneten 2 (Min) 	N/A N/A N/A	N/A N/A N/A	N/A N/A N/A	N/A N/A N/A	N/A N/A N/A
Gehen 2 (Min) 	N/A	N/A	N/A	N/A	N/A
Gehen 3 (Min) 	N/A	N/A	N/A	45 Hitze + kneten	N/A
Backen (Min) 	60	65	70	20 Gehen	60
	15 Gehen	15 Gehen	15 Gehen		
Warmhalten (Min) 	60	60	60	N/A	60
Zutaten hinzugeben (Stunden verbleibend)	N/A	N/A	N/A	N/A	N/A
Voreinstellung der Zeit	15h	15h	15h	N/A	15h

**DE
AT
CH**

Fehlerbehebung Brotbackautomat

Was tun, wenn der Knethaken 6 nach dem Backen in der Backform 7 stecken bleibt?	Füllen Sie heißes Wasser in die Backform 7 und drehen Sie den Knethaken 6 , um die Verkrustungen darunter zu lösen.
Was passiert, wenn das fertige Brot im Backautomaten bleibt?	Durch die „Warmhalte-Funktion“ wird sichergestellt, dass das Brot ca. 1 Std. warm gehalten und vor Feuchtigkeit geschützt wird. Sollte das Brot länger als 1 Stunde im Backautomaten bleiben, könnte es feucht werden.
Sind Backform 7 und Knethaken 6 spülmaschinengeeignet?	Nein. Bitte spülen Sie die Backform 7 und Knethaken 6 mit der Hand.
Warum wird der Teig nicht gerührt, obwohl der Motor läuft?	Überprüfen Sie, ob die Knethaken 6 und die Backform 7 richtig eingerastet sind.
Was tun, wenn der Knethaken 6 im Brot stecken bleibt?	Entfernen Sie den Knethaken 6 mit dem Knethakenentferner 10 .
Was passiert bei einem Stromausfall während eines Programms?	Bei einem Stromausfall bis 10 Minuten wird der Brotbackautomat das zuletzt ausgeführte Programm zu Ende führen.
Wie lange dauert das Brotbacken?	Bitte entnehmen Sie die genauen Zeiten der Tabelle „Programmablauf“.
Welche Brotgewichte kann ich backen?	Sie können Brote von 750 g - 1000 g - 1250 g backen.
Warum kann die Timer-Funktion beim Backen mit frischer Milch nicht benutzt werden?	Frische Produkte wie Milch oder Eier verderben, wenn sie zu lange in dem Gerät bleiben.
Was ist passiert, wenn der Brotbackautomat nicht arbeitet, nachdem man die Start/Stop-Taste 3 gedrückt hat?	Einige Arbeitsgänge wie zum Beispiel „Aufwärmen“ oder „Ruhen“ sind schwer zu erkennen. Kontrollieren Sie anhand der Tabelle „Programmablauf“, welcher Programmabschnitt gerade läuft. Kontrollieren Sie, ob das Gerät arbeitet, indem Sie prüfen, ob die Betriebsindikationslampe 3 leuchtet. Kontrollieren Sie, ob Sie die Start/Stop-Taste 3 richtig gedrückt haben. Kontrollieren Sie, ob der Netzstecker an das Stromnetz angeschlossen ist.
Das Gerät zerhackt die beigegebenen Rosinen.	Um das Zerkleinern von Zutaten wie Obst oder Nüssen zu vermeiden, geben Sie diese erst nach Ertönen des Signals zum Teig.



KOMPERNASS HANDELS GMBH

BURGSTRASSE 21

44867 BOCHUM

DEUTSCHLAND / GERMANY

www.kompernass.com

Last Information Update · Stanje informacija · Versiunea informațiilor

Έκδοση των πληροφοριών · Stand der Informationen:

08 / 2015 · Ident.-No.: SBB850C1-072015-1

IAN 270356